



WILDLIFE
ACOUSTICS

Check for
new firmware
before deploying.
See Section 9.6.



See Page 1 for
Quick Start Checklist

Song Meter SM4BAT FS

BIOACOUSTICS RECORDER

User Guide

Last updated on 09/23/2022

CONTENTS

1	Quick Start Checklist	1
2	Overview	2
	2.1 Introduction	2
	2.2 Visual Tour	3
	2.3 The Main Menu	3
3	Setup and Installation	5
	3.1 Opening the Recorder	5
	3.2 Turning Power On and Off	6
	3.3 Installing Internal Batteries	6
	3.4 Connecting External Power	7
	3.5 Inserting SD Memory Cards	8
	3.6 Connecting and Mounting a Microphone	9
	3.7 Protecting the Recorder	12
	3.8 Protecting the Microphone	13
	3.9 Connecting the GPS Accessory	17
	3.10 RS-232 Monitoring Interface	18
	3.11 Securing the Recorder	18
	3.12 Locking the Keypad	18
	3.13 Mounting the Recorder	20
	3.14 Replacing the Clock Battery	20
	3.15 Reading the Recorder Temperature	20
4	Settings	21
	4.1 Navigating the Menus	21
	4.2 Setting the Date and Time	21
	4.3 Setting the Device Prefix for Recorded Files	22
	4.4 Setting the Location and Time Zone	22
	4.5 Setting the Solar Calculation Method	23
	4.6 Audio Settings	23
	4.7 Setting a Delayed Start	27
	4.8 Setting the LED Indicator Mode	27
	4.9 Advanced Settings	28
5	Making Scheduled Recordings	29
	5.1 Recording Operation Overview	29
	5.2 Using a Quick Start Schedule	29
	5.3 The Recording Screens	30
	5.4 Checking the Status of the Recorder	31
	5.5 Stopping a Recording Schedule	32
	5.6 Making an Instant Recording	32

5.7	Retrieving and Analyzing Recordings	33
5.8	Recording Files	33
5.9	Recording Metadata	33
5.10	Recording Summary Text File	34
6	Creating Custom Simple Schedules	36
6.1	Schedule Blocks	36
6.2	SM4 Configurator Software	37
6.3	Editing a Schedule	38
6.4	Adding or Deleting Schedule Blocks.....	38
6.5	Schedule Block Examples.....	39
7	Creating Custom Advanced Schedules	41
7.1	Creating and Editing an Advanced Schedule	41
7.2	Using Loops	42
7.3	Advanced Schedule Commands	43
7.4	How to Work with the Schedule Checker.....	44
7.5	How to Resolve Schedule Checker Errors.....	45
8	Importing and Exporting Schedules	46
8.1	SM4 Configurator Software	46
8.2	Importing a Schedule.....	46
8.3	Exporting a Schedule	47
9	Utilities	48
9.1	Exporting Diagnostics	48
9.2	Resetting to Factory Default Settings.....	48
9.3	Calibrating Microphones	48
9.4	Monitoring Ultrasound in Time Expansion Mode	51
9.5	Formatting SD Memory Cards.....	52
9.6	Updating the Firmware.....	53
10	Specifications	54
10.1	Physical	54
10.2	Power	55
10.3	SD Memory Cards	56
10.4	Ultrasonic Audio	56
10.5	SMM-U1 Ultrasonic Microphone	56
10.6	SMM-U2 Ultrasonic Microphone	56
11	Warranty and Disclosures	58

Revised and Translated User Guides

This guide is regularly updated and improved. New versions can be downloaded from <http://www.wildlifeacoustics.com/support/documentation>. It is also available from the same webpage in Spanish, French, German, Chinese and Japanese translations.

Tutorial Videos

Visit www.wildlifeacoustics.com/support/tutorial-videos to view tutorial videos for the Song Meter SM4BAT FS.

Contacting Support

For technical queries contact the Wildlife Acoustics support team:

<https://www.wildlifeacoustics.com/contact-us>

North America (toll-free): 1-888-733-0200

Outside North America (toll charges may apply): +1 978-369-5225

Don't miss out on Important Updates

We continually add features to the Song Meter SM4BAT FS. Stay up to date with the newest features and receive important technical support bulletins by signing up to our mailing list at:

<http://www.wildlifeacoustics.com/products#mailinglist>

1 Quick Start Checklist

- ❑ Release the side latch, open the security cover, and then open the middle section to access the battery bay. Check that the gasket is undamaged and free of debris that will interfere with the seal.
- ❑ Install four (4) new alkaline or NiMH D batteries. Close the middle section. To use external batteries, see *Connecting External Power in Chapter 3*.
- ❑ Insert one SD memory card in slot A and an optional second card in slot B.
- ❑ Reformat card(s) using the built in format utility (see *Formatting SD Memory Cards* in the Utilities Chapter).
- ❑ Slide the power switch down to **INT** for internal battery power. The recorder powers on and the main menu appears on the display. (If using an external power source, slide the switch up to **EXT**.)
- ❑ Press **CHECK STATUS** to verify the time, microphone, SD memory cards, battery voltage, temperature, and firmware version.
- ❑ Check Wildlife Acoustics' website for new firmware and update if necessary (see section 9.6).
- ❑ Use the keypad to select **Quick Start** and choose a recording schedule.
- ❑ Navigate to **Main Menu > Settings** to set the time and date. For schedules that start or end at times relative to sunrise or sunset (for example, *Record Sunset→Rise*), you must also set the latitude and longitude and time zone. Alternatively, temporarily attach the available GPS accessory to auto-set, the location, date, and; however, you must manually set the time zone. It is not set by the GPS and must be set prior to plugging in the GPS for the recorder to correctly calculate local time from GPS time.
- ❑ Press the **SCHEDULE START** button. The schedule begins:
 - The SM4BAT *sleeps* (display goes blank) to conserve battery power if a recording is not scheduled in the next 45 seconds.
 - The SM4BAT *wakes* (display illuminates) at the next scheduled recording start time and saves recordings to the SD memory card(s).
 - The display shows the next recording period and **ARMED** when listening for bats. **TRIGGERED** appears when recording.
- ❑ Close the security cover and latch. To secure the recorder, attach an optional lock. Mount the recorder in a suitable location and leave.
- ❑ When the deployment ends, press and hold **SCHEDULE STOP** to finish recording. Eject the SD memory card(s) and review the recordings.

2 Overview

2.1 Introduction

The latest generation in the Song Meter series, the SM4BAT FS is a weatherproof, programmable, single channel, full-spectrum, ultrasonic recorder designed for the periodic, seasonal, and long-term monitoring of bats and other ultrasound wildlife in almost any environmental condition. The SM4BAT FS creates high-quality, full-spectrum 16-bit WAV recordings that can be easily viewed or analyzed using our Kaleidoscope software (or third-party software).



You can schedule daily recordings to meet a variety of needs including times that are relative to sunrise and sunset, specific duty cycles with on/off recording patterns, and continuous monitoring all day and all night. The SM4BAT FS optimizes battery life and memory capacity to record for extended periods of time. Using both memory slots and new alkaline batteries, a typical deployment can record for up to 48 ten-hour nights.

Features

- Lightweight, portable, and completely weatherproof
- One-channel full-spectrum 16-bit WAV recorder
- Intelligent recording trigger and noise scrubber to minimize false recordings of non-bat activity
- Up to 48 ten-hour nights of recording using four (4) alkaline D batteries
- SMM-U2 and SMM-U1 microphones support cables up to 100m(includes 3m)
- Supports one or two standard SDHC or SDXC memory cards
- Weatherproof keypad and backlit display for easy entry and status
- Dual-color LED indicator provides recording and triggering feedback
- Integrated top and bottom mounting flanges are designed to work with cable locks, screws, radiator clamps, bungee cords, and other fasteners
- Easy to set up and use with convenient Quick Start daily recording schedules and one-touch start
- Advanced Schedule mode allows creation of more advanced schedules
- Customize schedules and estimate impacts on SD memory cards and battery life with the free SM4 Configurator software
- One-touch status check shows memory card utilization, battery voltage, and other recorder health information without interrupting recordings
- External power option using an SM3/SM4 power cable (sold separately)
- Self-generated diagnostics assist in basic troubleshooting
- Internal temperature and battery voltage logging
- Headphone port for real-time monitoring and system verification
- Optional GPS accessory automatically sets the date, time, latitude, and longitude and logs recording coordinates

2.2 Visual Tour



ITEM:	DESCRIPTION:
Security Cover	Protects the recorder. The cover swings open/closed and can be secured with a standard lock (sold separately).
LED Status Indicator	Flashes  red once every two seconds when armed and waiting for a triggered recording to start and  green once a second while triggered and making a recording.
Latch	Grip and pull to open the security cover. To close, push the security cover down until the latch clicks.
Keypad	Press the keypad buttons to navigate the menus and options on the display. Buttons include ▲Up or ▼Down , ◀Left or ▶Right , ENTER , SCHEDULE START , SCHEDULE STOP , and CHECK STATUS .
Mounting Flanges	Rugged and ready for almost any environment. Use the top and bottom cutouts to mount the recorder.
Power Switch	Slide down to turn power on using internal battery (INT). Slide up to use optional external power (EXT) or to turn off (if no external power).
Display	Backlit screen displays all main menu items, settings, values, message prompts, and status information.
Memory Slots A and B	Insert removable SD memory cards to store recordings.
Lock Ring	Insert the shackle of an optional key or combination lock to secure your recorder.
GPS Connection	Use the available GPS option to automatically set the date, time, and location settings.
Pressure Vent	Temperature, UV, and water-resistant vent and a self-regenerating desiccant packet control humidity and prevent condensation.
Headphone Jack	Connect headphones and listen to live bat activity using Time Expansion mode.

2.3 The Main Menu

Refer to the following table when navigating the main menu on the display.

Menu Item	Description
Quick Start	
Record Sunset→Rise	Based on your location, date, and sunrise/sunset settings, records continuously from sunset until sunrise.
Record-30Set-→+30Rise	Records from 30 minutes before sunset to 30 minutes after sunrise.
Record Always	Records continuously 24 hours a day.
Settings	
Audio	Configure audio settings for recordings.
Date and Time	Set the local date and time for your recorder.
Location	Set the recorder prefix ID and the latitude, longitude, and time zone for your location.
Sunrise/Sunset Type	Set the method used to calculate the sunrise and sunset times. Choices include astronomical, civil, or nautical twilights or the actual sunrise/set times
Delay Start	Delay the start of your daily schedule until 00:00 on a specified date.
LED Indicator	Choose to display LED indicators always or only for the first several minutes after you start the schedule.
Advanced	Settings for advanced users.
Schedule	
Edit Schedule	Add, modify, or delete schedule blocks.
Import Sched+Setts	Import a schedule and settings from an SD card.
Export Sched+Setts	Export the current schedule and settings to an SD card.
Utilities	
Time Expansion Mode	Listen to bat activity through headphones.
Export Diagnostics	Save status and troubleshooting information to an SD card to send to the Wildlife Acoustics Support Team.
Set factory default	Restore the original recorder settings to their factory-fresh values and revert to a like-new state. CAUTION: Any custom schedules or settings are replaced.
Calibrate Mic	Test the sensitivity levels of the connected microphone with the available Ultrasonic Calibrator.
Format all cards	Erase and reformat the SD memory cards. CAUTION: All data on the cards is permanently lost.
Firmware Update	Update the recorder with a new firmware file that you download to an SD memory card.

3 Setup and Installation

3.1 Opening the Recorder

When instructed by the procedures in this guide to open the recorder, follow the steps below.



1. Locate the handle for the security cover on the front right side of the recorder as shown.
2. Grip the handle and lightly pull it to release the latch. The cover flips open and rotates along its hinged spine like a book, exposing the display and keypad in the middle section. At this point, you can insert memory cards, adjust the power switch, and connect an optional GPS or headphones. Continue with the next step only when you are installing batteries.
3. Press the small circular indentation between SD memory card slots A and B with your thumb to release the middle section. If it is difficult to release the section, press down closer to the gasket seam. This section swings open exposing the battery bay.

To close the cover, reverse the steps:

NOTE: Before deployment, examine the black rubber gaskets around the edge of the front and back of the control panel. The gasket should be free of debris and tears. Note that exposure to unusually high levels of UV exposure can soften or degrade the rubber. Consider covering the SM4's gasket with some opaque tape or cloth to extend life. DEET, a common ingredient in insect repellent, is known to degrade the plastic used in the SM4's enclosure. Replacement gaskets are easy to install and can be ordered by contacting our support team.

1. Gently and firmly push the middle section (display and keypad) down until it snaps into place.

2. Gently and firmly push the security cover down until it snaps into place.
3. Align the security cover latch with the locking ring and snap into place.

3.2 Turning Power On and Off

Follow these steps to switch recorder power on and off based on your choice of internal or external power source. Only one power source (internal or external) can be active at a time.

1. Open the cover to access the power switch on the side of the middle section above memory slot A.
2. Slide the switch down to **INT** to turn power on when using internal batteries; slide the switch up to **EXT** to turn power on when connected to an external battery. Only one power source is used at a time. Whichever position does not have a battery installed is functionally *off*.
3. When you want to turn the recorder off to conserve battery power, slide the switch to the opposite position (**EXT** when using internal batteries and **INT** when using an external battery).

NOTE: Do not turn the power off when a recording is in progress. To safely exit from recording, press **SCHEDULE STOP**, allow the recorder to return to the **Main Menu**, and then switch the power off. Avoid quickly switching power off and on again (avoid quick switches between **INT** and **EXT**). The recorder can interpret this sudden loss and restoration of power as an error and may start creating diagnostics.

3.3 Installing Internal Batteries

The recorder uses four size D alkaline or NiMH batteries.

NOTE: We prefer Energizer brand of alkaline batteries for their superior performance.

The SM4BAT FS enters a very low-power sleep state between scheduled recordings to conserve energy and maximize efficiency for long deployments.

TIP: Prior to installation, we recommend that you test all batteries with a high-quality pulse load battery tester such as the ZTS MINI-MBT.

1. Open the recorder.
2. Insert batteries with their polarity (+/-) orientation as shown on the battery bay markings.

NOTE: Do not mix batteries of different types, and do not mix old and new batteries. Remove batteries before storing the recorder for an extended time.

3. Close the middle section and gently press down until it snaps into place.
4. To turn on power, slide the power switch to **INT**.

- When not in use, set the power switch to **EXT** to conserve internal battery power. With no external battery source, consider the **EXT** position to be *off*. Only one power source (internal or external) can be active at a time.

TIP: Use the Song Meter SM4 Configurator software to estimate the recording requirements for your schedules including battery life and memory storage.

3.4 Connecting External Power

With the optional external power cable, the power connector can accept voltages from 5-17 volts DC. It is intended for 6 or 12-volt external batteries.

CAUTION: If you are unfamiliar with configuring external battery and power systems, consult a local installer for assistance.

- Each power cable is shipped with a snap-on ferrite to meet standards limiting electromagnetic emissions and protecting against electrostatic discharge. Install the ferrite near the end of the cable as close to the recorder as possible. The image shows the ferrite as shipped (right) and as installed (left).
- Loop the cable through and snap the ferrite shut. A zip tie is included for further securing the ferrite. The image shows the ferrite as shipped (right) and as installed (left).
- Align and seat the cable into the **EXT POWER** port on the side of the recorder. Turn the grey locking ring (black on older SM3 cables) clockwise \cup firmly until it locks into place.



- The external power cable includes F2-size spade connectors and ring terminals. Connect the cable to a 6 or 12-volt battery using one of the connectors provided. The SM4BAT FS provides protection against accidental reverse polarity connections.

- Open the security cover and slide the power switch up to **EXT**.
- (Optional) Set a minimum voltage to prevent damage to lead-acid batteries that are not designed for deep discharge.
- When not in use, set the power switch down to **INT** to conserve external battery power. With no internal batteries installed, consider the **INT** position to be *off*.

3.5 Inserting SD Memory Cards

The SM4BAT FS saves recordings to one or two SD memory cards installed in the memory card slots.

NOTE: Be sure the card's write protection switch is "off". The SM4BAT will not record to a write-protected card.

On a typical night of bat activity with no rain, the recorder might use about half a gigabyte (0.5 GB). With considerable bat activity it is possible to use several gigabytes per night.

The following table shows the total recording capacity in hours for each card size by sampling rate to help you choose the right memory card size. This is the total time of all triggered or non-triggered WAV files.

SD Memory Card (GB)	Sample Rate:			
	192 kHz	256 kHz	384 kHz	500 kHz
16	12	9	6	5
32	23	17	12	9
64	46	35	23	18
128	93	70	47	36
256	185	139	93	71
512	370	278	185	142

NOTE: The above table shows recording capacity for uncompressed WAV recordings. Three levels of compression can be set in the Audio Settings menus that will significantly increase these times. More information can be found in the Audio Settings section 4.6 of this guide.

- Open the security cover and locate memory slots A and B on the side below the power switch.
- Insert one required SD memory card slot A or B. Push the card straight in until it clicks into place. Make sure the small read/write switch on the card is to allow write access.



in
until
set

3. (Optional) To extend deployments, or to have a redundant card in case there is an issue with the first, insert a second SD memory card in the remaining slot.

NOTE: You can use slot A, slot B, or both for recording; however, when importing and exporting schedules or updating the firmware you must use slot A.

4. Reformat card(s) using the built-in format utility (see *Formatting SD Memory Cards* in the Utilities Chapter).
5. Press **Check Status** and verify that the card is shown with an appropriate capacity.
6. To remove a card when recording is completed, push it in and release it. The spring-loaded slot ejects your card so you can pull it away.

NOTE: Do not remove SD memory cards while the SM4BAT FS is recording. This could corrupt the card.

3.6 Connecting and Mounting a Microphone

You must connect an available SMM-U2 or SMM-U1 microphone to record bats.

SMM-U2

The SMM-U2 is the newest generation of microphone and improves upon the SMM-U1 with lower noise, better weather protection, and much lower cost. The SMM-U2 also draw less power than the SMM-U1, resulting in approximately 10% longer run times. The SMM-U2 microphone's low noise and superior sensitivity results in quieter recordings, recording bats at greater distances, and longer triggered recordings.



The SMM-U2's higher signal-to-noise ratio results in more and longer recordings with lower noise.

The higher signal-to-noise ratio means less noise from the microphone and higher signal. This allows the microphone to pick up fainter or more distant bats when recording. The SMM-U2 covers approximately 8 times as much airspace as the SMM-U1. The quieter recordings also result in cleaner, easier to analyze recordings that last longer and include more bat echolocation pulses. The microphone has a differential output which significantly reduces noise from electromagnetic sources.

The enclosure's innovative waterproof design includes a built-in mounting bracket that allows for a wide range of mounting options. The SMM-U2 has a cardioid sensitivity pattern which means it is most sensitive to the front and sides and less sensitive to the back. For most applications, it is recommended to mount the microphone pointing straight up to the sky. That will maximize coverage volume in the air and minimize ground noises from insects. The microphone's built-in mounting bracket has L-shaped zip-tie holes that also allow mounting horizontally for applications where the bat activity is from a known direction, such as a cave exit.



For frequency response and signal to noise graphs and specifications, please go to: <https://www.wildlifeacoustics.com/products/song-meter-sm4bat>.

SMM-U1

The previous generation microphone, the SMM-U1, can still be purchased when it is necessary to maintain the same sensitivity and directionality for your research projects. The SMM-U1 features similar sensitivity to all major brands of bat recorders, but we recommend the SMM-U2 for its superior signal-to-noise ratio and weather protection.



For frequency response and signal to noise graphs and specifications, please go to: <https://www.wildlifeacoustics.com/products/song-meter-sm4bat>

Connecting the Microphone to the SM4BAT

The SMM-U2 microphone comes with a 5-meter cable permanently attached and the SMM-U1 microphone includes a 3-meter extension cable. Both microphones can be extended up to 100 meters with available extension cables in 10 and 50-meter lengths with no signal attenuation or degradation. All connections are fully waterproof.

1. Each extension cable is shipped with a snap-on ferrite to meet standards limiting electromagnetic emissions and protecting against electrostatic discharge. Install the ferrite near the end of the cable as close to the recorder as possible.

2. Loop the cable through and snap the ferrite shut. A zip tie is included for further securing the ferrite. The image shows the ferrite as shipped (right) and as installed (left).



3. Align and seat the cable into the keyed **MIC** connector.
4. Turn the grey locking ring (black on SM3 cables) on the microphone or cable clockwise \odot firmly until it locks into place.
5. Replace the windscreen when the foam begins to break down and flake. With normal outdoor use over time, the foam windscreen fades to brown; however, color degradation does not indicate a loss of integrity.

Mounting the Microphone for the Best Recording Quality

To assure the best possible recording:

1. Test the microphone when it is first received and regularly thereafter using an Ultrasonic Calibrator available from Wildlife Acoustics. This will allow you to quickly detect a loss in sensitivity.
2. Mount the microphone away from all solid surfaces including the recorder itself, walls, ground, water, tree branches and trunks and foliage to avoid recording echoes or dispersing the sound.
3. Position the microphone in the middle of the bat flyway to assure that the bat is as close as possible to the microphone.

Ultrasonic Directional Horn Attachment for SMM-U1

The cardioid SMM-U2 and omnidirectional SMM-U1 are ideal for unattended monitoring where the precise direction of bat activity is not known in advance. In applications requiring more directionality, the SMM-U1 microphone can be adapted for directional sensitivity with the available directional horn.

The Ultrasonic Directional Horn converts the SMM-U1 into a highly directional microphone, while preserving echolocation call quality. The attachment remains weatherproof at angles up to 45-degrees from horizontal.



3.7 Protecting the Recorder

Protecting the SM4BAT FS from Electrostatic Discharge

The Song Meter Surge Suppressor protects the recorder from power surges from electrostatic discharge or electrical storm activity that could come down the microphone cable and damage the recorder. This accessory should be used wherever microphones are mounted at elevation. The Surge Suppressor is installed between a microphone cable and the recorder and includes a grounding attachment which is connected to a good earth ground. This ensures that an electric surge travelling down the microphone cable is shunted to ground before damaging the recorder.



Prevent the SM4BAT FS From Leaking

The SM4 family of recorders are designed with all kinds of weather in mind, and will not let in any water under normal circumstances. However, there are a few routine checks that should be done to make sure that your recorder is as weatherproof as it was when you received it:

- Examine the black rubber gaskets around the edge of the front and back of the control panel. The gasket should be free of debris and tears. Note that exposure to unusually high levels of UV can soften or degrade the rubber, and DEET, a common ingredient in insect repellent, is known to degrade the plastic used in the SM4's enclosure. Some plant oils may also soften the SM4's rubber gasket over extended periods of exposure. When possible, avoid contact with insect repellents, and in very sunny areas, consider covering the SM4's gasket with some opaque tape or cloth. Replacement gaskets are easy to install and can be ordered by contacting our sales team.
- Avoid putting strain on the SM4's case by mounting it too tightly. This can create torque that causes the SM4's case to open slightly. Note that trees can sometimes grow rapidly enough to cause further strain on equipment that has been mounted on them.
- Ensure the hexagonal pressure vent on the right side of the recorder is hand-tightened and undamaged. Pressure vents can be purchased from our sales team. To get any damaged microphone ports repaired, please contact our support team.

3.8 Protecting the Microphone

Protecting the SMM-U2 from Electrostatic Discharge

Mounting microphones high off the ground, especially in dry or windy conditions, could result in microphone damage from electrostatic build-up. The available SMM-U2 Grounding bracket protects the microphone by directing static discharge through a metal screen to an attached wire which is connected to an earth ground. We

recommend checking with a professional licensed electrician or installer with experience in outdoor antennas or weather instruments for advice suitable to your situation. See section above on how to protect the recorder using the available Song Meter Surge Suppressor.



NOTE: The SMM-U2 microphone has passed IEC 61000-4-2 (15kV) ESD testing with the properly grounded surge suppressor (with ferrite) and properly grounded microphone (with additional ferrite at the microphone end). Testing includes ESD up to 30kV with no damage caused to the microphone. While this offers significantly better protection against electrical surges than without protection, microphones can still be damaged by lightning and stronger electrical surges caused from static discharge and electrical storm activity.

Protecting the for SMM-U2 from Water Damage

The SMM-U2 microphone is a waterproof and weatherproof ultrasonic microphone that can be fully immersed in liquid water or placed in nearly any weather without suffering permanent damage like its predecessors and other ultrasonic microphones on the market.

A special membrane transparent to ultrasound seals the sensitive ultrasonic sensor from water intrusion at depths of up to one meter. The membrane itself is fragile to tearing, so an additional stainless-steel mesh protects the membrane from physical damage caused by wind-blown particulates and animals such as birds, rodents and insects. Finally, the electronics and connections inside the microphone are potted in epoxy sealing them from the elements.

NOTE: Do not remove the front or rear labels on the SMM-U2 microphone.

Weatherproof is not the same as all-weather

While the SMM-U2 cannot be damaged by water, it does not necessarily record bats in the presence of rain or dew. In the presence of liquid water caused by precipitation or dew, the stainless-steel mesh will hold water in its grid through

capillary action forming a wall of water in front of the ultrasonic sensor. This wall of water effectively blocks most ultrasound. For example, a 40kHz signal can be attenuated by more than 40dB as a result of the presence of water trapped in the grid.

This means that the SMM-U2 may stop recording bats if the grid gets wet e.g. due to rain or dew until the water can evaporate. Evaporation times will vary depending on the orientation of the microphone, relative humidity, temperature, wind speed and barometric pressure. In humid environments, the cooling at night can cause condensation to form on the mesh as the dew point is reached, and evaporation will not occur until the air warms during the day.

Optimize Orientation

If the SMM-U2 sensor is aimed horizontal (e.g. parallel to the ground), a light rain event might not get the mesh wet allowing the SMM-U2 to record bats. However, a wind-blown rain could blow water onto the mesh resulting in signal loss until the water can evaporate. If the SMM-U2 sensor is facing the sky, additional rain water can pool in the label opening above the grid further increasing evaporation times.

For this reason, the SMM-U2 without additional weatherproofing may not record bats reliably in wet conditions. It should be noted that most other microphones will also fail to record bats when they are wet.

Countermeasures to improve performance in rain and wet conditions

We found that orienting the SMM-U2 so the sensor is aimed horizontally (e.g. parallel to the ground) will improve wet-weather recording when compared to orienting the SMM-U2 so the sensor is facing the sky. However, windblown rain or condensation can still cause water to form in the mesh resulting in attenuation. To mitigate this further, we found adding an acoustically transparent windscreen around the SMM-U2 can prevent water from building up on the mesh. Instead, water tends to stay within the pours of the foam and wick away toward the bottom of the foam due to gravity.

Our recommendation for recording bats in the rain is to stretch a 1" inner-diameter acoustically transparent foam windscreen over the SMM-U2 as shown in the figure below and to orient the SMM-U2 so the sensor is facing parallel to the ground. The WT600 extra-large windscreen is recommended and available on our website store under replacement parts for US \$10.

The following figure shows several SMM-U2s in different orientations.

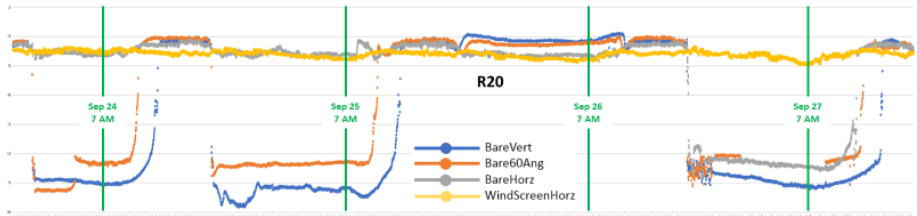

Left to right, the drops in sensitivity are approximately during the periods:

9/23 23:50 to 9/24 13:00
 9/24 17:00 to 9/25 13:00
 9/26 16:30 to 9/27 16:00

Rain amounts:

0.04" ending 7AM 9/24
 0.02" ending 7AM 9/25
 0.00" ending 7AM 9/26
 0.32" ending 7AM 9/27

The windscreen unit is not affected while all others are impacted to varying degrees.

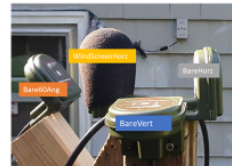

In the excel data files these were:
—●— BARE-VERT —●— BARE-60ANG —●— BARE-HORIZ —●— WIND-SCREEN

Test Data R18-R23

A 40kHz signal was broadcast at these microphones and their sensitivity was measured through several rain events. The chart below shows the attenuation caused by water filling the mesh and blocking ultrasound. As you can see, the horizontally-oriented microphone with a windscreen never lost any significant sensitivity. The horizontally-oriented microphone without a windscreen was able to record for two out of three of the rain events shown. The microphones oriented straight up or at approximately 45 degrees to vertical both experienced significant signal loss during the rain events until evaporation occurred.

SMM-U2 Water Protection Summary

If you want to record bats with an SMM-U2 in wet environments, we recommend that you aim the microphone sensor horizontally rather than vertically and use a WT600 large windscreen.

Protecting the SMM-U1 from Electrostatic Discharge

Mounting microphones high off the ground, especially in dry or windy conditions, could result in microphone damage from electro-static build-up. We recommend checking with a professional licensed electrician or installer with experience in outdoor antennas or weather instruments for advice suitable to your situation. Here are some tips to avoid damage:

- Avoid mounting microphones on tall plastic masts including those made of fiberglass or nylon for deployments in dry conditions. A breeze flowing over the plastic mast can build up a sizeable electrical charge much like rubbing a balloon. Eventually, the electric charge will be strong enough to discharge with an attraction to the mass of metal in the cable resulting in a spark that could damage the microphone. Wood or metal masts will mitigate this problem.
- If the best path to ground is through the microphone and/or SM4BAT then the microphone and/or the recorder could be severely damaged. To protect against this, you need to create a better and safer alternate path to ground, much the

way a lightning rod on a house functions. One way to do this is to use a pipe clamp to clamp a heavy gauge (12 AWG) wire from the microphone to ground by securing the other end of the wire to the metal frame of a grounded tower structure, or securing the wire to a metal pipe planted 2 meters into the earth. The connections must be electrically strong with low resistance.

- See section above on how to protect the recorder using the available Song Meter Surge Suppressor.

Protecting the for SMM-U1 from Water Damage

When installed correctly, the SMM-U1 microphone is completely weatherproof. It features a hydrophobic membrane that is transparent to acoustic or ultrasound signals. This membrane prevents unpressurized water from entering the microphone.

The included microphone windscreen should be installed for long-term deployments in all areas susceptible to heavy wind-driven rain to avoid permanent damage to the microphone element due to water penetration. For short-term deployments in dry climates, windscreens are not necessary, but recommend as a precaution. Windscreens attenuate ultrasound by only a 1-2 dB when dry, however, when wet they can attenuate by another 3-5 dB until dry again. Drying time can vary significantly based on temperature, humidity, and wind conditions, but in as little as ten minutes, a couple dB will have been regained.

Secure the windscreen to the SMM-U1 microphone with the included C-clip. Allow an air gap between the windscreen and the microphone as shown.

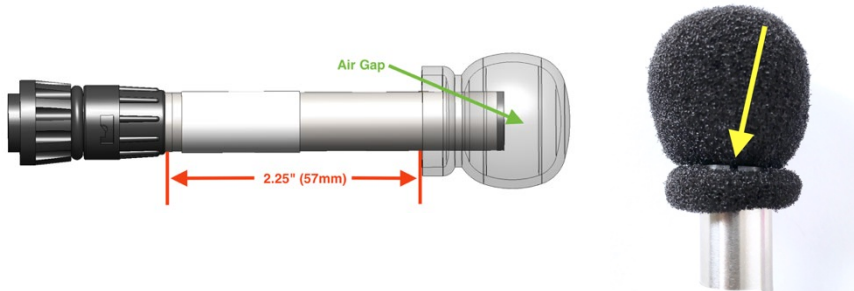

Do not handle or remove a wet windscreen as it is easy to accidentally squeeze the windscreen and push water into the end of the microphone.

We also recommend positioning the microphone so that it is aimed at least slightly downward to minimize water entry. Bat activity from above is still recorded in this orientation because the microphone is omnidirectional.

The above recommendations on the use of a microphone windscreen also apply to the Horn attachment. When advised,



secure the large windscreen with the included zip-tie as shown.

3.9 Connecting the GPS Accessory

The optional GPS accessory automatically sets the date, time, latitude, and longitude of the recorder. If you have several SM4BAT recorders to deploy in the field, you can use a single GPS accessory to set them up. The real-time GPS location will be saved in the recording's meta-data if the GPS is attached during recording. This can be useful for transect surveys.

1. Navigate to **Main Menu > Settings > Location > Timezone** and set the time zone. The GPS does not set the time zone.

NOTE: The time zone must be set prior to using the available GPS accessory to automatically set the correct time. The SM4BAT FS adjusts the time from the GPS based on the time zone setting and sets the recorder's clock after this calculation. If you change the time zone after the clock has been set, this automatic adjustment does not take place and the clock will not be set correctly.

2. Open the security cover and plug the GPS cable into the GPS port on the side of the recorder.
3. The recorder automatically detects the presence of the GPS. When the recorder wakes up, the GPS is powered up.
4. Wait for the GPS to communicate with the satellites.



- a. A few seconds after connecting the GPS Accessory, the GPS status is shown on the top right of all menu screens. When the GPS has successfully communicated with the satellites, the status changes from asterisks to FIX.
 - b. Or, on the CHECK STATUS screen, a question mark (?) appears between the date and time to indicate that the GPS accessory is attempting to acquire satellite data.
5. When the GPS has successfully acquired satellite data, the question mark (?) changes to a number sign (#) and the location, date, and time are automatically set. Coordinates are given in decimal degrees and use the WGS-84 coordinate system.

NOTE: The **Location Settings** coordinates as seen on the display in the main menu are read-only when the GPS is attached. You cannot change them.

6. Disconnect the GPS. The available GPS accessory consumes about 90 mA of additional current—more than four times the current of the recorder itself. For passive recording, we recommend that you use the GPS to automatically set

the clock and location at the beginning of the deployment but do not keep it attached for the duration of the deployment.

NOTE: If you are still prompted for latitude and longitude when starting a schedule, it most likely means the GPS accessory does not yet have a fix. Be aware that it can be difficult to acquire a GPS signal in thick vegetation. Also note that the GPS cannot be used for precision time synchronization on the SM4BAT FS as it can on the SM3BAT.

3.10 RS-232 Monitoring Interface

SM4BAT FS recorders produced with serial numbers greater than S4U06942 (shipped on or after March 12, 2019), are capable of outputting serial communications to report bat activity to wind energy SCADA. Using an available cable that connects to the **EXT POWER** port, the recorder responds to serial requests from a third-party data logger with information including cumulative number of bat passes and pulses detected as well as timestamp, voltage, temperature, and flash card capacity information. Contact our support team for more information.

3.11 Securing the Recorder

Close the cover to protect the recorder from environmental conditions. To secure the recorder with a standard key or combination lock, press the latch down and insert the lock shackle through the lock ring.

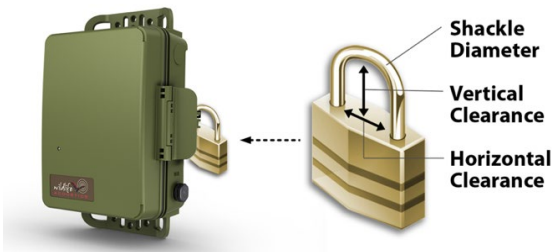

Observe the following size requirements for the lock:

	Minimum:	Maximum:
Shackle Diameter	1/8 inch (3 mm)	3/8 inch (9 mm)
Vertical Clearance	5/8 inch (16 mm)	1.0 inch (25 mm)
Horizontal Clearance	1/2 inch (13 mm)	1.0 inch (25 mm)

NOTE: The lock should be rated for outdoor use.

3.12 Locking the Keypad

For large scale projects, it is occasionally desirable to lock down the SM4BAT such that only authorized personnel are able to modify the configuration. This can

prevent modifications by someone who may inadvertently put deployments at risk by making changes without understanding their consequences.

The SM4 Configurator software can be used to export an .SM4S configuration file that will require a user-selectable 4-digit code to change any settings on the recorder. The user can still navigate through all the menus and screens. However, any attempt to change configuration settings or the clock will fail with an error. The time and GPS coordinates may still be set/updated by plugging in the GPS accessory.

NOTE: This is not a cryptographic solution but the level of security is sufficient to prevent the casual user from changing configuration settings that could impact the success of a deployment.

A locked recorder will show [LOCKED] in the lower right corner of the Main Menu.

Use the steps below in the SM4 Configuration Utility to lock or unlock a recorder.

1. Configure your schedule and settings as normal in the SM4 Configuration program.
2. Save the .SM4S configuration file using the menu selection "*File->Save with lock/unlock code...*". The user is prompted to enter a 4-digit code and indicate if the configuration is to be locked or unlocked.
3. When the .SM4S configuration file is imported into the SM4BAT from the "*Schedule->Import Sched+Setts*" menu, the recorder will be in one of the following states depending on whether the recorder was locked or unlocked and if the .SM4S is locked with a code or not:
 - a. If the SM4BAT was unlocked and the .SM4S file is locked with a code, the SM4BAT configuration will be updated and locked with the code. The user will first be prompted to make sure they understand that the configuration will be locked.
 - b. If the SM4BAT was locked, and the .SM4S file is unlocked with a matching code, the SM4BAT configuration will be updated and unlocked. This is how an SM4BAT can be returned to an unlocked state.
 - c. If the SM4BAT was locked, and the .SM4S file is locked with a matching code, the SM4BAT configuration will be updated and the SM4BAT remains locked with the code. This is how a locked configuration can be updated with a new locked configuration.
 - d. If the SM4BAT was locked, and the .SM4S does not contain a matching code, then the import will fail with an appropriate error.

WARNING: Once the recorder has been locked, it cannot be unlocked without the proper code except by contacting Wildlife Acoustics Support.

3.13 Mounting the Recorder

Use the holes in the top and bottom mounting bracket for mounting the recorder with cable locks, screws, radiator clamps, bungee cords, or other fasteners.

NOTE: Do not mount the recorder using a cable lock or other nonflexible cord to a growing tree. Circumferential growth could cause the cable to warp or break the recorder's mounting bracket. The tree won't like it either.



3.14 Replacing the Clock Battery

A separate button cell CR2032 lithium battery maintains real-time clock settings when the four main D batteries are being exchanged or are no longer operational. The included battery should last up to 3 years. Use the steps below to replace the internal clock battery.

1. Open the security cover and the middle section to access the battery bay.
2. Locate the circular **CLOCK BATTERY** bay behind the display and keypad opposite the main battery bay.
3. Gently insert a flathead screwdriver to pry the old battery out.
4. Slide a new battery under the two pins on the top side with the CR2032 lettering facing you.
5. Push down on the lower side until you feel the battery seat.



3.15 Reading the Recorder Temperature

The recorder includes an integrated temperature sensor to log temperatures inside the enclosure. This is intended for diagnostics only. Heat from the electronics and/or sunlight on the enclosure can significantly increase the temperature reading above ambient air conditions.

Press the **CHECK STATUS** button to view the current temperature reading.

4 Settings

4.1 Navigating the Menus

To navigate the main menu, select items, and configure the values for various settings, use the following basic steps. All procedures in this guide assume you are familiar with these steps.

1. Press **▲ Up** or **▼ Down** and **ENTER** to navigate any menu.
For example, navigate to **Main Menu > Settings > LED Indicator**.
2. Press **ENTER** or **▶ Right** to select menu items and continue to the next editable item. (**ENTER** and **▶ Right** are interchangeable in the menus with the exception of the line where schedule blocks are added and deleted.)
3. Press **▲ Up** or **▼ Down** to select values.

Tip: To accelerate the pace when selecting higher or lower values, press and continue to hold down the **▲ Up** or **▼ Down** arrow buttons.

4. Press **ENTER** or **▶ Right** to save your edits.
5. Repeat these steps as required. The exact buttons used may vary by setting.
6. Press **◀ Left** to exit a line without saving or to return to the previous menu.

TIP: For improved visibility in low-light environments, press any button on the keypad to illuminate the display. The backlight remains lit while you continue operating the recorder and turns itself off after 30 seconds of inactivity.

4.2 Setting the Date and Time

Follow these steps to set the date and time manually unless you are using the available GPS accessory to automatically set the current date and time.

1. Navigate to **Main Menu > Settings > Date and Time**.
The date and time appear on one line in the following format:

YYYY-MMM-DD HH:MM:SS

2017-Oct-22 20:17:45

2. Press **▶ Right** to set the date (year, month, and calendar day). As you adjust the month and day, the corresponding sunrise and sunset times appear (according to the Sunrise/Sunset Type setting) for that date.
3. Press **▶ Right** to set the time (hours, minutes, and seconds).
4. To adjust any value, press **▲ Up** or **▼ Down**.
5. Press **ENTER** when finished.

NOTE: The recorder does not automatically adjust for Daylight Saving Time.

4.3 Setting the Device Prefix for Recorded Files

The prefix appears in the name of every recording file to easily identify the recordings made on a specific recorder or from a common shared schedule. The default prefix combines the model number with the serial number. You can specify a custom filename prefix of up to 12 characters to identify each recorder.

1. Navigate to **Main Menu > Settings > Location > Prefix**.
2. Specify a 1 to 12 character prefix from left to right:
 - a. At the first position, press **▲ Up** to cycle through the alphabetic characters A to Z. Press **▼ Down** to cycle through the numbers 9 to 0. You can also select a hyphen (it is above the digit 9).
 - b. Press **▶ Right** to advance to the next position in the prefix and repeat the previous step.
3. To erase characters, select the blank character that is above the hyphen and below the letter A. All of the characters to the right of the blank character are erased.
4. When finished, press **▶ Right** to advance to the last position and then press **ENTER**.

NOTE: The prefix can only contain capital letters, numbers, and hyphens. When you change the default prefix, the serial number of the recorder no longer appears in the recording file names; however, it does still appear in the metadata inside the file.

4.4 Setting the Location and Time Zone

You must manually set these parameters if you are not using the available GPS accessory to automatically set the latitude and longitude. The time zone cannot be set automatically by the GPS and must be set manually.

NOTE: The time zone must be set prior to using the available GPS accessory to automatically set the correct time. The SM4BAT FS adjusts the time from the GPS based on the time zone setting and sets the recorder's clock after this calculation. If you change the time zone after the clock has been set, this automatic adjustment does not take place and the clock will not be set correctly.

The selections you make for latitude, longitude, and time zone enable the recorder to determine the specific sunrise and sunset times for each day.

Specify the local time zone (as used to set the clock) in hours relative to UTC (Universal Time Coordinated). Exact hour, half, and quarter time zones (:00 :15 :30 :45) are supported.

NOTE: Schedules and settings exported from one recorder and imported on a second recorder do not overwrite the **Prefix, Latitude and Longitude, Time Zone, or Battery Cutoff** settings on the second recorder. Schedules created or edited by the Song Meter SM4 Configurator software can selectively overwrite any setting upon import.

1. Navigate to **Main Menu > Settings > Location > Latitude.**
 - a. To enter degrees of latitude north of the equator, press ▲ **Up.**
 - b. To enter degrees of latitude south of the equator, press ▼ **Down.**
2. Navigate to **Main Menu > Settings > Location > Longitude.**
 - a. To enter degrees of longitude west of the prime meridian, press ▲ **Up.**
 - b. To enter degrees of longitude east of the prime meridian, press ▼ **Down.**
3. Navigate to **Main Menu > Settings > Location > Timezone.**
Enter the time zone relative to UTC.

NOTE: The recorder does not automatically adjust for Daylight Saving Time.

4.5 Setting the Solar Calculation Method

The SM4BAT FS can schedule recordings relative to sunrise and sunset times, and adjusts these times as they change during the year. You can choose from four different methods of calculating the sunrise and sunset.

1. Navigate to **Main Menu > Settings > Sunrise/Sunset Type.**
1. Select one of the following solar calculation types:
 - **sunrise/set:** When the sun is just below the horizon.
 - **civil:** When the sun is 6 degrees below the horizon.
 - **nautical:** When the sun is 12 degrees below the horizon.
 - **astronomical:** When the sun is 18 degrees below the horizon.
2. The calculated sunrise and sunset times for the method that you select appear for today. For example:

```
Sunrise/Sunset Type
-Solar nautical

Rise 05:12 Set 18:57
```

3. Press **ENTER** to save your changes.

NOTE: Sunrise and sunset calculations also require other settings including the date and time, latitude and longitude, and time zone.

4.6 Audio Settings

When your schedule starts, it applies your current audio settings. When you import or export a schedule, the settings are included.

1. Navigate to **Main Menu > Settings > Audio.**
2. Select an audio setting. To adjust its value, press ▲ **Up** or ▼ **Down.**

3. Press **ENTER** to save your changes.

Each audio setting is described below:

Gain

You can adjust the gain setting to boost the input level of the audio signal from the microphone. We recommend 12 dB unless the bats are very close in which case 0 dB might work better.

Values: 0 or 12 dB

Default: 12 dB

16k High Filter

This sets the 16 kHz analog high-pass filter. A high-pass filter allows signals only higher than the specified frequency to be recorded.

The high-pass filter is a two-pole filter, which attenuates sounds at 12dB per octave. When the filter is on, an 8 kHz sound would be attenuated by 12dB as it is one octave lower than the 16 kHz frequency of the filter. Every 6dB represents a halving of sound level, so the 8 kHz sound would appear in the recording at one-fourth of its original amplitude.

The SMM-U2 has a built in 2-pole, 1 kHz high-pass filter and the SMM-U1 microphone has a built-in 4-pole, 8 kHz high-pass. If you expect bats vocalizing below 16 kHz, set the 16k high filter to *off* and an appropriate Min Trig Freq (see below). The filter in the microphone reduces acoustic sounds below the threshold frequency but you will still get more noise files with setting this filter to off, it's a compromise. If you do not expect bats below 16 kHz, set the 16k high filter to *on* in order to reduce acoustic sounds that might cause non-bat recordings to occur and also set an appropriate Min Trig Freq (see below).

Values: on or off

Default: off

Sample Rate

Your choice of rate determines the number of samples per second used to store any sounds detected during a recording period. Higher sample rates provide the ability to record higher frequencies. Choose a sample rate that is at least double the highest frequency to be recorded.

Values (kHz): 192, 256, 384, or 500

Default: 256 kHz

Min Duration

Sets the minimum duration of a signal in the specified frequency range that qualifies as a valid signal for the scrubber. The scrubber automatically rejects recordings if it detects no suitable bat echolocation call. The scrubber looks for at

least two narrow-band signals of at least this minimum duration, shorter than the maximum duration, and within the frequency range you specified. If two such signals exist, the file is saved; otherwise, the file is not saved.

A value of 1.5 ms is recommended for recording bats.

NOTE: To disable the scrubber, set **Min Duration** and **Max Duration** to *none*.

Range: none, 0.1 to 99.9 milliseconds in 0.1-millisecond increments

Default: 1.5 ms

Max Duration

Sets the maximum duration of a signal in the specified frequency range that qualifies as a valid signal for the scrubber. A value of *none* is recommended for recording bats.

Range: none, 1 to 500.0 milliseconds in 1-millisecond increments

Default: none

Min Trig Freq

Use this command to set the lower bound for the frequencies of interest to the triggering mechanism and noise scrubber. Echolocation calls or other signals occurring below this frequency do not cause a trigger and are considered noise to the scrubber. A setting of 16 kHz works well for most bat applications. It may be necessary to reduce this setting for recording lower-frequency species.

Range: 2 to 99 kHz in 1-kHz increments

Default: 16 kHz

Trigger Level

Specifies the digital trigger level and type.

Positive values define a trigger that is set relative to the measured noise floor so the trigger adapts to the surroundings. 12 dB, for example, will trigger if the signal is more than 12 dB louder than the background noise within any frequency band higher than **Min Trig Freq**. This is the trigger type we recommend as it will maximize detections.

Negative values define an absolute trigger with a threshold that is relative to full scale signal. -18 dB, for example, will trigger if the signal is within 18dB of full scale.

The trigger is satisfied if a signal exceeds the specified dB level is above the frequency defined by **Min Trig Freq**. The recorder creates an individual time-stamped WAV file for each triggered event during the scheduled recording period.

NOTE: The trigger is inactive for up to a second after the end of a triggered recording to allow time for the file to be written.

Turning on the trigger also activates file scrubbing. For information on the scrubber, including how to turn it off, see **Min Duration**.

When you turn off the **Trigger Level** setting, the **Trigger Window**, **Min Trig Freq**, **Min Duration**, and **Max Duration** settings are ignored and continuous recordings are made as defined in the recording schedule and subject to the **Max Length** setting.

Range: -78 dB to 24 dB in 6 dB increments and OFF

Default: 12 dB

Trigger Window

The recording continues for this amount of time after the last signal that satisfies the trigger. (The recording is also truncated when it reaches the maximum recording duration set by **Max Length**.) Set the trigger window setting long enough to avoid a recording that ends after one echolocation call.

For example, if bat echolocation calls occur every 0.5 seconds and trigger window is 0.1 seconds, you would get a new trigger with every single echolocation call. Three (3.0) seconds is a good default value.

NOTE: Some standards describe a specific recording trigger window as a *bat pass*.

Values: 0.1 to 15 seconds in 0.1-second increments

Default: 3 seconds

Max Length

You can specify the maximum length (time duration) of recordings to comply with file size restrictions of your analysis software or to fulfill a specific recording protocol or definition of a bat pass. The **Max Length** setting takes effect regardless of whether the **Trigger Level** setting is on or off.

The recorder also enforces a 2.0 GB maximum recording file size. When a recording reaches either maximum, it ends and a new recording file starts.

Values: 1 second to 60 minutes 1-second increments

Default: 00m:15s

Compression

SM4BAT WAV file compression can be selected to record in a proprietary compressed W4V format. The W4V format is a WAV file compression developed specifically for minimizing loss of useful information in bioacoustics audio recordings while maximizing compression to save on valuable card space. W4V records the same rich meta-data as when recording to WAV. There are three compression levels which result in the following compression:

- W4V-8: 50% (allows recording twice as long on a given card as compared to uncompressed WAV)

- W4V-6: 62.5% (allows recording almost three times as long on a given card as compared to uncompressed WAV)
- W4V-4: 75% (allows recording four times as long on a given card as compared to uncompressed WAV)

The compression algorithm does increase the noise floor of the recording but for most bioacoustics uses, the difference between an uncompressed WAV and W4V-8 and W4V-6 will be undetectable since the noise floor in the recorded environment will be higher than the increased recording noise floor. W4V-4 will likely cause a slight increase in broadband noise in the background of the recording. It is best to experiment with your particular environment to make sure the increased noise is either undetectable or tolerable.

Wildlife Acoustics' Kaleidoscope Viewer and Pro software can natively open the compression formats. The free Kaleidoscope Converter can be used to convert the files to standard WAV format for use in other software packages. Additionally, the W4V algorithms are open-source under GPLv3 license. Please contact us if you are interested in a commercial license.

Values (Hz): none, W4V-8, W4V-6, or W4V-4

Default: none

4.7 Setting a Delayed Start

The Delay Start setting waits until a future date to start your schedule. The recorder delays the start of the schedule until 00:00 of the specified day.

1. Navigate to **Main Menu > Settings > Delay Start**.
2. Set a future start date and set **Enable** to yes.

NOTE: You can use this feature to synchronize the start of two or more recorders.

When you start the schedule, a warning appears reminding you of the delayed start. If the date is in the past, no warning appears and the schedule starts without delay.

4.8 Setting the LED Indicator Mode

The LED indicator in the keypad blinks to indicate the recorder status. The LED blinks red once every two seconds when in an armed state waiting for a trigger and green once per second when triggered. This light is visible on the front of the recorder even when the security cover is closed.

1. Navigate to **Main Menu > Settings > LED Indicator**.
2. Choose *always* or *5 minutes only*.

When you choose *5 minutes only*, the LED only appears for approximately the first five (5) minutes of recording after you press **SCHEDULE START** or **CHECK STATUS** or until the first time the unit sleeps. This setting minimizes drawing

attention to the recorder and allows you to maintain some level of camouflage when recorder security or visibility is a concern.

4.9 Advanced Settings

The following describes each advanced setting.

Setting a Minimum External Battery Voltage

You can set a minimum voltage cutoff to help prevent damage to external lead acid batteries from over-discharge. If the external battery voltage falls below this cutoff, the schedule is suspended. The SM4BAT then wakes every 24 hours to check the voltage and resumes the schedule if the voltage is restored.

1. Navigate to **Main Menu > Settings > Advanced > Battery Cutoff**.
2. Press **▲ Up** or **▼ Down** to adjust the power cutoff in volts from 0.0 to 12.0 in 0.1-volt increments.
3. Press **ENTER** to save your changes.

NOTE: Leave the cutoff value at 0.0 if you are using internal batteries. Any non-zero setting decreases internal battery life as the recorder prematurely suspends operation. Also use a setting of 0.0 for external batteries that are designed for deep discharge.

Selecting Schedule Mode

The SM4BAT can operate in Simple Schedule Mode or Advanced Schedule Mode.

1. **Main Menu > Settings > Advanced > Schedule Mode**
2. Use the **▲ Up** or **▼ Down** buttons to toggle between the two modes.

The Simple Schedule Mode is easier to configure but has the limitation of only being able to perform the same schedule every day. The Advanced Schedule Mode can be programmed to run different recording schedules on different days.

5 Making Scheduled Recordings

5.1 Recording Operation Overview

The SM4BAT FS is a full-spectrum recorder. It samples audio signals at a specified sample rate and saves full-spectrum 16-bit WAV files to SD memory cards. The recording schedule determines when each day the SM4BAT FS records and when it sleeps while waiting for a recording period. In most cases, the recorder is configured to make triggered recordings of bat activity.

Recordings are initiated with the configurable trigger and saved only if they make it through the configurable noise scrubber, which automatically deletes recordings that do not appear to contain bats. You can also configure the recorder to make non-triggered recordings which record all the time during the scheduled recording periods defined by the schedule. You can also deactivate the scrubber to avoid deleting non-bat recordings.

This chapter guides you in using the Quick Start schedules, and the next two chapters describe creating your own Simple or Advanced schedule, as well as importing and exporting schedules.

5.2 Using a Quick Start Schedule

The Quick Start menu includes pre-configured schedules intended to satisfy most customer requirements. They also serve as excellent starting points for editing your own schedule if you need something a little different. Creating custom schedules is described in the next chapter but the remainder of this chapter should be read first to understand how to run any schedule.

1. Navigate to **Main Menu > Quick Start**.
2. Choose one of following Quick Start schedules and press **ENTER**.

Name	Definition of schedule
Record Sunset→Rise	Based on your location, date and sunrise/sunset settings, records continuously from sunset until sunrise.
Record-30Set-→+30Rise	Records from 30 minutes before sunset to 30 minutes after sunrise.
Record Always	Records continuously 24 hours a day.

NOTE: It is advised to use the SM4 Configurator software whenever possible to double-check that the chosen schedule will behave as desired. These same quick start programs are available in the Configurator to allow you to easily enter your location and double-check your schedule on the graphical calendar.

3. When you change schedules, a confirmation message appears:

```

Overwrite Schedule?
-No
-Yes

```

- Select *No* to keep the previously loaded schedule and exit.
- Select *Yes* to continue loading the selected schedule. This overwrites the old schedule. All other settings are unchanged.

Tip: If you want to save any custom edits or blocks you made to a schedule, select *No* here to go back and export that schedule to a memory card. Then, you can choose a new schedule and select *Yes* here with confidence knowing that your previous schedule was backed up.

4. Press **SCHEDULE START** to start the schedule. If you are not ready to start it yet, press ◀ **Left** to return to the Quick Start menu.

NOTE: The recorder automatically attempts to start the current schedule after three (3) minutes of inactivity.

5. When you press **SCHEDULE START**, warning messages may alert you about required settings, missing SD memory cards, or incompatible or missing microphones. Each warning appears for several seconds.
 - Press ▼ **Down** to proceed to the next warning. After the last warning, the recorder attempts to run the schedule.
 - Press **SCHEDULE STOP** or ◀ **Left** to avoid running the schedule and return to the main menu. Adjust any settings or hardware to resolve the warnings. Press **SCHEDULE START** again when you are ready.
6. The recorder shows **Preparing to record** and indicates if the next recording period is continuous or covers a specific timespan:

```

2017-Dec-05 10:58:37
Preparing to record
A CONTINUOUS #00001

```

```

2017-Apr-25 10:59:37
Preparing to record
B 11:00-17:00 #00088

```

If the first recording period start time is more than 45 seconds into the future, the recorder goes to sleep to conserve power:

```

2017-Feb-10 11:05:00
Going to sleep until
2017-Feb-10 19:15:00

```

The recorder wakes up 30 seconds before the next scheduled recording period so that it is ready to record on time.

5.3 The Recording Screens

The following screens appear when recording with the trigger on:

```
2017-Apr-25 23:50:48
Preparing to record
B 18:45-07:15 #00101
```

```
2017-Apr-25 23:50:48
Currently Recording:
B 18:45-07:15 #00101
ARMED @ SR=384k
```

```
2017-May-22 23:50:48
Currently Recording:
B 18:45-07:15 #00101
TRIGGERED @ SR=384k
```

```
2017-Apr-25 23:50:48
Currently Recording:
B 18:45-07:15 #00101
PREPARING @ SR=384k
```

The following screen appears when recording with the trigger off:

```
2017-Apr-25 23:50:48
Currently Recording:
B 18:45-07:15 #00102
RECORD @ SR=384k
```

These example screens show the following details:

Line 1: The current date and time.

Line 2: The **Currently Recording:** status message.

Line 3: The current SD memory card slot that the recorder is writing to (**A** or **B**), followed by the beginning and ending times of the current recording period or **CONTINUOUS** if the schedule is set to record all the time (the Quick Start *Record Always* schedule for example). On the right side of the same line is the running count of recording files saved since the recorder was last powered on.

Line 4: The state of the device and the sample rate.

- **PREPARING:** the recorder is writing the file to the SD memory card.
- **ARMED:** the recorder is waiting for audio activity to trigger a recording.
- **TRIGGERED:** the recorder is making a triggered recording.
- **RECORD:** a non-triggered recording is being made.

5.4 Checking the Status of the Recorder

We recommend that you perform this procedure to check the status of the recorder and SD memory cards before every deployment.

1. Press the **CHECK STATUS** button.

NOTE: When the recorder is sleeping, you must press and hold the button to see status. First you will see a boot screen and then the “Going to sleep until” screen appears. Another press of the Check Status button is required to view the Check Status screen shown below.

- The Check Status screen appears. For example:

```
2017-Oct-23 09:14:48
R:1.0.0      Mic:U2
SDA: 7/64 B: EMPTY
Bat: 5.2V Temp:16.70
```

- **Line 1:** The current date and time.
- **Line 2:** The installed firmware version and connected microphone:
U2: SMM-U2 microphone
U1: SMM-U1 microphone
NA: no microphone is connected
- **Line 3:** The consumed memory as a fraction of the total capacity in GB for the SD memory cards in slots A and B. In this example, 7 GB have already been used on a 64 GB card in slot A and there is no card in slot B.

NOTE: *WP* will appear in place of the consumed memory for any card with a write-protection switch ON.

- **Line 4:** The internal battery or external power supply voltage, and the internal temperature in degrees Celsius.

NOTE: The internal temperature of the recorder is intended for diagnostics and not as an accurate measurement of outside air temperature.

- Press the **CHECK STATUS** button again to return to the previous screen.

5.5 Stopping a Recording Schedule

When a schedule is running, or scheduled to run, you have the option to stop it.

- Press and hold the **SCHEDULE STOP** button for several seconds.
- When you stop a running schedule, the current recording is saved to the SD memory card before it ends.
- The recorder automatically attempts to resume the current recording schedule after three (3) minutes of inactivity. When not recording for an extended period of time, power the recorder *off*.

5.6 Making an Instant Recording

In addition to running a schedule, you can start an instant recording anytime. Starting an instant recording is like forcing the Quick Start **Record Always** schedule for 24 hours.

- Verify the recorder is turned on and displaying the main menu. If the recorder is sleeping, press and hold **SCHEDULE STOP** to wake it.

2. Press and hold both the ▲ **Up** and ▼ **Down** keys at the same time.
3. After showing **Preparing to record**, the recorder immediately starts recording based on your audio settings.
4. Press **SCHEDULE STOP** to stop instant recording. After 24 hours, instant recording will automatically stop and the current schedule will start.

5.7 Retrieving and Analyzing Recordings

Transfer recordings to your computer by removing the SD memory card (s) from the recorder and copying the files to your computer using a built-in or USB memory card reader.

NOTE: If the recorder is left to run until the batteries are mostly depleted, it is possible that you will find the SD memory card(s) in a DIRTY state. The recordings are fine and can still be transferred to your computer. Once you have transferred all recordings, clear the DIRTY state using the built-in formatting utility. see *Formatting SD Memory Cards* in the Utilities Chapter for more information. In addition, there will likely be multiple .sm4dump files on the card as the recorder assumes there is an issue when the power is intermittent. These can be ignored. It is also possible to get a **fatal clock error** if the batteries were fully depleted, this will not persist once batteries are replaced.

The recordings are compatible with all popular third-party full-spectrum analysis programs available. Wildlife Acoustics recommends and supports our Kaleidoscope software, which allows you to easily view and classify your recordings. Kaleidoscope Viewer is a free download and Kaleidoscope Pro with bat Auto-ID is available for purchase at www.wildlifeacoustics.com.

5.8 Recording Files

Audio recording files are saved in the **Data** folder on each SD memory card and use the following naming convention:

PREFIX_YYYYMMDD_HHMMSS.wav

PREFIX: The current prefix as set in the location settings.

YYYYMMDD_HHMMSS: The date-time stamp including the year, month, day, hour, minute, and second when the recording started.

.wav: The audio file name extension for Waveform Audio File Format (WAVE)

5.9 Recording Metadata

Values for the attributes listed below are stored as metadata in your recordings. The Wildlife Acoustics Support Team can use the metadata when troubleshooting issues.

NOTE: You can open a recording in the SM4 Configurator computer software to view the schedule and settings used to make the recording. Also, some of the metadata information

is visible in the available Kaleidoscope computer software. Kaleidoscope has the ability to add additional metadata relating to analysis of the recording.

Device Model: The device model name. For example, *SM4BAT FS*.

Device Serial Number: The unique serial number of your recorder.

Firmware Version: The firmware version installed on the recorder.

Prefix: The prefix assigned to the recorder in the location settings.

Timestamp: The date and time when the recording started.

GPS Coordinates: The location of the SM4BAT FS when the recording first started. The file metadata stores the location coordinates that you manually entered on the recorder as well as the coordinates from the GPS accessory if attached. Coordinates from the GPS will have the text string WGS84.

Schedule and Settings: The schedule and all settings in use when the recording was made.

5.10 Recording Summary Text File

Approximately once per minute during a recording, the SM4BAT FS appends a line to the summary text (.txt) file. This file is in comma-separated values (.csv) format. You can open it in Microsoft Excel, in database software, or in a text editor. The file begins with a header line which identifies the fields that appear in each line of summary data:

```
DATE, TIME, LAT, , LON, , POWER(V), TEMP(C), #FILES, #SCRUBBED, MIC0 TYPE
```

Three (3) lines from an example summary file appear below:

```
2017-Jan-22,17:15:24,42.00000,N,71.00000,W,5.9,12.00,1,1,U1
2017-Jan-22,17:16:38,42.20000,N,71.10000,W,5.9,11.75,0,4,U1
2017-Jan-22,17:17:47,42.35000,N,71.18200,W,5.9,11.75,2,2,U1
```

DATE & TIME: The date and time for each entry. This is the time taking into account the time zone set in the location settings.

LAT & LON: Latitude and longitude coordinates in decimal degrees with identifiers for north (N), south (S), east (E), and west (W). If the GPS accessory is installed at the time the log entry is written, the identifiers are capitalized indicating that the latitude and longitude was written from the GPS using the WGS-84 coordinate system. If no GPS is attached, the identifiers are lower case indicating that the coordinates were previously written by GPS or entered by the user.

POWER(V): The internal battery or external power supply voltage. In the example, the voltage is 5.9 volts.

TEMP(C): The temperature in degrees Celsius inside the recorder. In the example, the internal temperature has fallen from 12.00 to 11.75 degrees.

#FILES: The number of recording files written since the previous summary file line. Since a new summary line is written once per minute, if your recording is longer

than 1 minute, a zero appears on all lines until the recording ends. In the example, 1, 0, and 2 files were written during each respective one-minute period.

#SCRUBBED: This is the number of WAV files that were scrubbed, based on the audio settings, since the previous summary file line. These files were not saved on the SD memory card. In the example 1, 4, and 2 files were scrubbed during each respective one-minute period.

MIC_TYPE: The microphone type attached during recording. U2 indicates a SMM-U2 microphone and U1 indicates an SMM-U1 microphone.

6 Creating Custom Simple Schedules

In addition to using one of the Quick Start schedules, you can create your own schedule using the built-in editor, or import a schedule from an SD memory card made on another recorder or the Song Meter SM4 Configurator software on your computer. You can also export the current schedule to an SD memory card.

NOTE: It is advised to use the SM4 Configurator Software whenever possible to double-check that the programmed schedule will behave as desired. Programs created on the SM4BAT FS can also be double-checked by importing them into the Configurator and viewing on the graphical calendar.

SM4BAT FS schedules are flexible and portable. Schedules exported from recorders or created by the Song Meter SM4 Configurator software include all configurable settings. The appropriate settings are applied when a schedule is imported. This coupling of schedules with their settings enables you to share entire configurations from one recorder to another.

6.1 Schedule Blocks

Schedule blocks are the core components that define a daily recording schedule. Every schedule has at least one block. A block has the following three lines:

```
START:  time hh:mm or
        rise +/-hh:mm or
        set  +/-hh:mm

DUTY:   always or
        ON hh:mm OFF hh:mm

END:    time hh:mm or
        rise +/-hh:mm or
        set  +/-hh:mm
```

Each block defines a single continuous recording period between its **START** and **END** times if **DUTY** is **always**, or a series of smaller periods if **DUTY** is on that repeat between the **START** and **END** times. The combination of all the duty cycles and recording periods generated by all the blocks makes up the daily recording schedule.

The **START** and **END** times for the block can be a fixed time or relative to sunset or sunrise. Times are specified using a 24-hour clock (HH:MM). When relative to sunset or sunrise, a positive (+) or negative (–) offset can be specified.

The **DUTY** cycle determines how often recording occurs between the start and end times. When set to **always**, recording is continuous between the start and end times. When set to **ON** and **OFF**, recording occurs for the specified number of

hours and minutes (**ON**) followed by a period of inactivity (**OFF**). The duty cycle repeats as many times as possible before the **END** time is reached.

The duty cycle begins at the **START** time, not when you begin running the schedule. For example, if you begin the following schedule by pressing **SCHEDULE START** at 10:50, the recorder sleeps until the next 15-minute **ON** duty cycle occurs at 11:00.

```
START: time    07:00
DUTY: ON00:15OFF00:45
END:   time    19:00
01/01 [ADD]
```

A typical schedule might only need one block; however, you can combine up to ten (10) blocks in a single schedule and can even overlap them. The SM4BAT FS scans all blocks and combines all their recording periods.

For example, you can create a schedule to record continuously from sunset to sunrise in one block and to record 5 minutes on the hour throughout the whole day (24 hours) in another block. The recorder combines these, resulting in 5-minute recordings during the days and continuous recordings during the nights.

In another example, if one block generates a recording period from 08:00 to 10:00, and a second block generates a recording period from 09:00 to 11:00, the resulting schedule yields a single recording period from 08:00 to 11:00.

6.2 SM4 Configurator Software

In addition to configuring schedules and settings on the recorder, you can use the Song Meter SM4 Configurator software to confirm schedule behavior on a graphical calendar and to estimate power consumption and SD memory card usage for schedules that you plan to run.

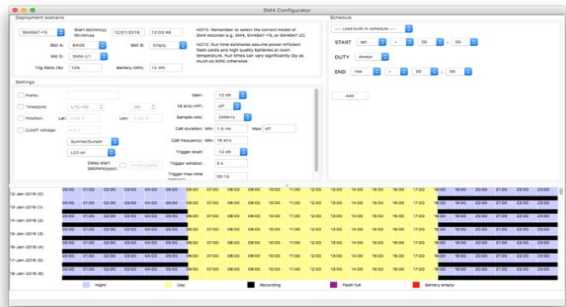

We recommend using the software to configure the recorder settings and schedule when possible as the additional visualization and information it provides allows you to be sure that your schedule and settings will perform as intended. The software is available for Mac, Windows, and Linux at no cost on our website at www.wildlifeacoustics.com. You can also open a WAV file made with the SM4BAT in the configurator to see the schedule and setting used to make the file. That information is stored in the meta-data of the WAV so it is always available in the future.

6.3 Editing a Schedule

Use this procedure to edit a schedule directly on the recorder using the display and buttons. We recommend that you edit schedules using the Song Meter SM4 Configurator software whenever possible; however, if you are in the field and need to edit a schedule, this method is convenient.

The recorder comes from the factory with the **Record Always** Quick Start schedule pre-loaded. You can select or import another schedule if that provides a better starting point for your custom schedule.

1. Navigate to **Main Menu > Schedule > Edit Schedule**.
2. Edit any of the three lines of a schedule block:
 - a. **START**: Press **▲ Up** or **▼ Down** to select rise, set, or a specific time. Press **▲ Up** or **▼ Down** to adjust the + plus or – minus sign for times that are relative to sunrise or sunset. For example, enter `rise -01:15` to start recording one hour and fifteen minutes before the calculated sunrise time.
 - b. **DUTY**: Schedules can record continuously between the **START** and **END** times (**always**) or for a specific repeating duty cycle within those times (**ON & OFF**). To learn more, see the schedule examples in this chapter.
 - c. **END**: Press **▲ Up** or **▼ Down** to select rise, set, or a specific time. Press **▲ Up** or **▼ Down** to adjust the + plus or – minus sign for times that are relative to sunrise or sunset. For example, enter `rise -01:15` to start recording one hour and fifteen minutes before the calculated sunrise time.
3. Press **ENTER** to save your changes.

TIP: To undo your changes in any line, you can press **◀ Left** to return to the start of the line and revert to its original value.

6.4 Adding or Deleting Schedule Blocks

When you edit a schedule, you can add or delete schedule blocks.

To add a new block:

1. Press **▼ Down** repeatedly to navigate to the bottom line of the last block in the schedule.
2. Press **▶ Right** to advance to the **[ADD]** label and press **ENTER** to add another block. The bottom line below the block shows the number of the block you are viewing and the total number of blocks.

```
START: time    00:00
DUTY:  always
END:   time    00:00
02/02  [ADD]   [DEL]
```

TIP: To move to the previous schedule block, press **▲ Up** when on the **START** line. To move to the next schedule block, press **▼ Down** when on the bottom line.

To delete a block:

1. Press **▲ Up** or **▼ Down** to navigate to the bottom line of the block you want to remove.
2. Press **► Right** to advance to **[DEL]** and press **ENTER**.

The following example stretches the display to demonstrate the concept of stacking code blocks in a series:

```

START: set      -00:05
DUTY:  always
END:   rise    +00:00
01/03  [DEL]

START: time     09:15
DUTY:  always
END:   time     11:15
02/03  [DEL]

START: set      +02:15
DUTY:  always
END:   rise    +01:30
03/03  [ADD] [DEL]

```

6.5 Schedule Block Examples

This section provides recording schedule examples that demonstrate how schedule blocks work. A schedule specifies when the SM4BAT FS records but does not necessarily result in a single file for the entire period. If you are making triggered recordings, then the number of recordings for a given schedule will be determined by the trigger and scrubber settings and by bat activity. If you are making non-triggered recordings, then the number of recordings for a given schedule will be determined by the **Max Length** setting.

Record Continuously All Hours of Every Day

The following schedule records continuously all day and night, 24 hours per day:

```

START: time     00:00
DUTY:  always
END:   time     00:00
01/01  [ADD]

```

This schedule appears under the **Quick Start** menu as **Record Always**. It runs continuously until you press **SCHEDULE STOP** or it runs out of power or SD memory card space.

Whenever the start and end times are identical and **DUTY** is set to **always**, your schedule is essentially the same as the **Record Always** schedule.

Record Continuously for a Portion of Each Day

The following schedule records continuously for the same six (6) hours daily:

```
START: time    04:00
DUTY:  always
END:   time    10:00
01/01  [ADD]
```

Record in 5-Minute Segments Every Hour

The following schedule records for 5 minutes at the beginning of each hour all day and continues indefinitely:

```
START: time    00:00
DUTY: ON00:05OFF00:55
END:   time    00:00
01/01  [ADD]
```

NOTE: The **ON** and **OFF** periods need not add up to an hour, but if they do not add up to a factor of 24 hours, the duty cycle truncates and restarts at the start time. For example, a duty cycle with **ON** 00:04 and **OFF** 00:03 divides 24 hours into 205 7-minute cycles plus one 5-minute partial cycle. In the 206th cycle, the schedule records for 4 minutes and then pauses for only 1 minute (instead of 3). This pattern repeats daily.

Record Continuously from Sunset to Sunrise

The following schedule starts every day at sunset and records continuously until sunrise on the following day:

```
START: set     -00:00
DUTY:  always
END:   rise    +00:00
01/01  [ADD]
```

This schedule appears under the **Quick Start** menu as **Record Sunset→Rise**.

Record in Multiple Blocks Relative to Sunset and Sunrise

The following schedule uses two blocks:

```
START: rise    -01:00
DUTY:  always
END:   rise    +01:00
01/02  [DEL]
```

```
START: set     -01:00
DUTY:  always
END:   set     +01:00
02/02  [ADD]  [DEL]
```

The first block defines a period relative to sunrise and the second block defines a period relative to sunset. The combined result records for two hours centered at sunrise and two hours centered at sunset.

7 Creating Custom Advanced Schedules

7.1 Creating and Editing an Advanced Schedule

Use this procedure to edit the currently active schedule directly on the recorder using the LCD screen and buttons. To learn more about each command and available settings, see 7.3 Advanced Schedule Commands.

You can create a new schedule from scratch at line 1 using the recorder.

1. At the **Song Meter Main Menu**, select **Schedule**, and press **ENTER/MENU**.
2. Press **▼ Down**, select **Edit Schedule**, and then press **ENTER/MENU**.
3. The following screen appears:

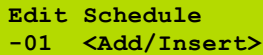

```

Edit Schedule
-01 <Add/Insert>
  
```

4. Press **► Right** and then press **▲ Up** or **▼ Down** to cycle through the available schedule commands.
5. Select a command and press **► Right**. Press **▲ Up** or **▼ Down** to adjust the associated parameters for the command.
6. Press **► Right** to complete line 01 and repeat these steps for line 02 and each subsequent line.
7. When finished, press **◀ Left** to check the schedule. Any schedule errors appear. Press **▼ Down** to cycle through multiple errors
8. Press **◀ Left** to exit.
9. Navigate to **Main Menu > Schedule > Edit Schedule**.
10. Press **▼ Down** to select a line in the schedule.
11. To edit the line, press **► Right** to advance to the command or value and then press **▲ Up** or **▼ Down** to make adjustments. When finished, press **◀ Left** or **ENTER/MENU**.
12. To add or insert a line:
 - a. Press **▲ Up** or **▼ Down** to select the **<Add/Insert>** entry on the last line of the schedule and press **ENTER/MENU**. A new line appears at the bottom of the schedule.
 - b. Press **◀ Left** and then press **▲ Up** or **▼ Down** to change the line number for the new line. Press **ENTER/MENU** to confirm the line number.

- c. To edit the new line, press ► **Right** to advance to the command or value and press ▲ **Up** or ▼ **Down** to make adjustments. When finished editing, press ► **Right** or **ENTER/MENU**.
13. To delete a line:
- a. Press ▲ **Up** or ▼ **Down** to select the line you want to delete.
 - b. Press ► **Right** to advance to the command for that line.
 - c. Press ▲ **Up** or ▼ **Down** until the <Delete> command appears.
 - d. Press **ENTER/MENU**. The line is removed and all higher lines cascade down in sequence by one line.
14. When finished editing all lines, press ◀ **Left**.
15. Any schedule errors appear. Repeat these steps to resolve the errors or press ◀ **Left** to ignore. Press ▼ **Down** to view the next problem. Press ▼ **Down** after the last problem to return to the **Schedule** menu. To return to the **Schedule** menu before reviewing all the problems, press ◀ **Left**.
16. When no errors exist, the following message appears:



Schedule edit OK

7.2 Using Loops

An essential logical structure in any computer schedule, a *loop* repeats a task until a necessary event occurs. For example, you need a schedule that waits, and continues to wait until sunrise; and then you want it to record, and repeat that action, recording over and over until 15 minutes before sunset.

Loops are programmed by using pairs of **REPEAT** and **UNT** (until) commands, nested to any depth. Loops have an explicit ending condition, such as a date for an **UNTDAT** command or a count for an **UNTCOUNT** command. In addition, loops have an implicit ending time, inherited from any enclosing loops. The implicit ending time is the earliest of all the enclosing loop ending times. In other words, the ending condition of a loop is either its own ending condition or the implicit ending time, whichever occurs first.

RECORD and **PLAY** commands likewise inherit an implicit ending time from any enclosing loops, perhaps causing a **RECORD** command to finish earlier than indicated by its own duration parameter or causing a **PLAY** command to not play its file at all.

UNTCOUNT loops do not have an ending time of their own, although they do pass along any implicit ending time that they inherit. If a schedule contains just one loop, a **REPEAT/UNTCOUNT** loop, with a **RECORD** command inside that loop, then the **RECORD** command will always run for its full duration, and the loop will end after the specified count of iterations.

7.3 Advanced Schedule Commands

Use the following commands to create schedules for your specific recording needs. An Advanced Schedule can contain up to 99 command lines.

NOTE: Some commands listed in this section refer to *sunrise* or *sunset* in a general sense and depend on them in schedule calculations. The recorder recognizes different methods for calculating precise sunrise and sunset times. To specify a method and view the next available sunrise and sunset times, select **Sunrise/Sunset Type** in the **Settings** menu.

AT DATE DDMMYY

Causes the schedule to wait until the specified date. YY are the last two digits of the year in the current century beginning with the year 2000.

NOTE: If you start the schedule after the specified **AT DATE**, the command is ignored and the schedule continues.

AT TIME hh:mm:ss

Causes the schedule to wait until the specified date time.

NOTE: If you use an AT TIME, AT SRIS or AT SSET command in a repeating schedule and start the schedule after the time indicated, the recorder will assume you wish to record starting at the previously occurring sunset, sunrise or time and begin recording immediately.

For example, if you have a schedule that starts with AT TIME 16:00:00 and you are in the field starting the schedule at 17:00:00, the recorder will not wait until 16:00:00 the next day, but instead will start recording immediately.

AT SRIS±hh:mm:ss

Causes the schedule to wait until sunrise, plus or minus the specified time.

AT SSET±hh:mm:ss

Causes the schedule to wait until sunset, plus or minus the specified time.

REPEAT

Indicates the beginning of a loop. Must be ended by an **UNT** command.

UNTDATA DDMMYY

Ends a loop when the specified termination date is reached. Any **RECORD** commands in progress in this loop are forced to stop recording.

UNTTIME hh:mm:ss

Ends a loop when the specified termination time is reached. Any **RECORD** commands in progress in this loop are forced to stop recording.

NOTE: If **UNTIME** is set to the same time as **AT TIME**, the recorder will not repeat the loop indefinitely, it will interpret that you wish to start and then instantly stop the loop and will not make any recordings within that loop.

UNTSRIS±hh:mm:ss

Ends a loop at sunrise, plus or minus the specified time. Any **RECORD** commands in progress in this loop are forced to stop recording.

UNTSSET±hh:mm:ss

Ends a loop at sunset, plus or minus the specified time. Any **RECORD** commands in progress in this loop are forced to stop recording.

UNTCOUNT {<count>, INF}

Ends a loop after <count> iterations. **INF** specifies an infinite count.

RECORD hh:mm:ss

Starts a new recording of the specified duration. If the **RECORD** command is inside a repeat/until loop, the recording may end early to match the outer loop ending time.

Recording files larger than 2.0 GB are divided into smaller segments.

The recording period will be broken into the length as set in the **Max Length** setting of the **Audio Settings** menu.

PAUSE hh:mm:ss

Pauses the schedule for the specified amount of time. If you set the duration of the **PAUSE** command to greater than 1 minute (3 minutes if using the GPS option), the SM4BAT enters low-power sleep mode and wakes up at the next scheduled recording.

7.4 How to Work with the Schedule Checker

The Schedule Checker runs automatically to verify the configuration of the hardware and software, and to check your schedule for errors or warnings. If it detects contradictory commands, the Schedule Checker reports the latter of the two as the error source. Use the Schedule Checker output to correct your schedule, save it, and then attempt to import or run it again.

1. The Schedule Checker runs at all of the following times:
 - After you finish loading or importing a schedule.
 - After you finish editing a schedule and press the main buttons on the device to exit the editor as viewed through the LCD screen.

- Before you press the **SCHEDULE START** button to run a schedule or if the schedule starts automatically after 3 minutes of no activity.
2. The Schedule Checker performs several tests on the current schedule and shows *errors* (if any), followed by *warnings* (if any), and their matching line number in your schedule.
 3. To view the next error or warning, press the **▼ Down** button.
 4. To exit the Schedule Checker, press the **◀ Left** button. You can also exit by pressing **▼ Down** after the last error or warning.
 5. If no buttons are pressed for 60 seconds while a problem is displayed, the Schedule Checker times out and exits.
 6. When the Schedule Checker exits:
 - If you were loading or editing a schedule, you return to the main menu.
 - If you were running a schedule and there are no errors (only warnings or no problems at all), your schedule starts.

7.5 How to Resolve Schedule Checker Errors

When a schedule contains *warnings*, you can address them or ignore them and continue, the schedule will run with *warnings*. However, when a schedule contains one or more *errors*, it will not run. To resolve an error, edit the schedule and adjust a parameter or add, move, or delete a command line. Refer to the following list of the most common possible schedule warnings and errors.

SM3 Schedule Errors and Warnings

Message	Explanation
Unmatched REPEAT:	a REPEAT command for which no corresponding subsequent UNT_X command can be found.
Unmatched UNTX:	an UNT_X command for which no corresponding preceding REPEAT command can be found.
Inf lp bfr REC:	the schedule has an infinite loop before reaching any RECORD command.
Unreachable command:	the schedule has commands following an infinite loop.
No RECORD:	the schedule contains neither a RECORD command.

8 Importing and Exporting Schedules

8.1 SM4 Configurator Software

In addition to configuring schedules and settings on the recorder, you can use the Song Meter SM4 Configurator software to confirm schedule behavior on a graphical calendar and to estimate power consumption and SD memory card usage for schedules that you plan to run.



We recommend using the software to configure the recorder's settings and schedule when possible as the additional visualization and information it provides allows you to be sure that your schedule and settings will perform as intended. The software is free and available for Mac, Windows, and Linux at www.wildlifeacoustics.com. You can also open a WAV file made with the SM4BAT in the configurator to see the schedule and setting used to make the file. That information is stored in the meta-data of the WAV so it is always available in the future.

8.2 Importing a Schedule

You can import a schedule file (for example, mySchedule.SM4S) from an SD memory card. The imported schedule includes the Simple Schedule as well as an Advanced Schedule, if one was created. It also includes settings.

NOTE: If both an Advanced Schedule and Simple Schedule are configured in the imported schedule, the selected schedule mode as set in Advanced Settings of the imported schedule will dictate which schedule is immediately loaded. To access the other schedule, simply change the schedule mode.

1. Save a custom schedule to the top-level directory (not in a folder) of an SD memory card from the Song Meter SM4 Configurator software, or export a schedule to an SD memory card from another recorder.
2. Insert the SD memory card in slot A of the recorder.

3. Navigate to **Main Menu > Schedule > Import Sched+Setts**.
4. At the **Select Schedule File** prompt, press **▲ Up** or **▼ Down** to select a schedule file on your SD memory card. Press **ENTER**.

NOTE: The file name must be 28 characters or less. The recorder does not recognize or display longer file names on the import screen.

5. If no warnings or errors are found, the following message appears and the imported schedule is now the current schedule:

Schedule imported

6. Press **◀ Left** to return to the **Schedule** menu. You can now edit or start the schedule.

NOTE: Schedules exported from a recorder and imported on another will not override the second recorder's **Prefix, Latitude, Longitude, Time zone, or Battery Cutoff** settings. Schedules created or edited by the Song Meter SM4 Configurator software have the option to override any of those settings.

8.3 Exporting a Schedule

You can export the schedule including its settings to an SD memory card. The Simple schedule is exported as well as the Advanced Schedule, if one was created. Which schedule will be loaded upon import to another recorder depends on the selected schedule mode as set in Advanced Settings on the recorder you are exporting from.

1. Insert an SD memory card in slot A.
2. Navigate to **Main Menu > Schedule > Export Sched+Setts**.

The following message appears:

Schedule exported

The exported file is named with the recorder prefix and the .SM4S extension. For example: SM400155.SM4S

The default prefix is the device model and serial number. You can specify a new prefix on the recorder in the settings.

CAUTION: If a file with that name already exists on the SD memory card, it is overwritten.

After exporting the schedule, you can share it with others, load it on another recorder, or edit it using the SM4 Configurator software.

9 Utilities

9.1 Exporting Diagnostics

This procedure exports a diagnostic file that can be used to assess the audio performance, settings, schedule, and status of the recorder. The Wildlife Acoustics Support Team can use this information to help diagnose problems. The recorder will also create a dump file temporary loss of power for over five seconds or if it senses other types of failures.

1. Insert an SD memory card into slot A.
2. Navigate to **Main Menu > Utilities > Export Diagnostics**.
3. The recorder performs internal diagnostic tests and then exports the test results, the current schedule, and the settings to a file. The file is named with the recorder prefix, the date and time, and the .sm4dump extension:
`PREFIX_YYYYMMDD_hhmmss.sm4dump`
4. Remove the SD memory card and insert it into a computer in order to send the file to Wildlife Acoustics.

9.2 Resetting to Factory Default Settings

This procedure restores all recorder settings to their original default values as they were configured when your recorder was first assembled and tested.

1. Navigate to **Main Menu > Utilities > Set factory default**.
2. Select *Yes* on the confirmation screen.

CAUTION: When you select *Yes* and reset defaults, your custom settings and any edited schedules are erased.

9.3 Calibrating Microphones

Use the available Ultrasonic Calibrator to calibrate an attached SMM-U2 or SMM-U1 microphone. Since ultrasound is beyond the range of human hearing, verifying performance requires special equipment. The Ultrasonic Calibrator helps you test both the microphone and the full recorder system.

The calibrator uses a 9V alkaline battery (included with the calibrator). When the battery is depleted, the calibrator can no longer provide a tone and its LED no longer illuminates. While the recorder may still emit sound at this point, it cannot be used as an accurate calibrator until the battery is replaced.

The calibrator offers two modes of operation:

- **CAL:** Calibration mode is used to test the microphone at close range.
- **CHIRP:** Chirp mode is used to test the entire system at a greater distance.

Calibration Mode Microphone Testing

3. Verify that you have attached an SMM-U2 or SMM-U1 ultrasonic microphone.
4. Navigate to **Main Menu > Utilities > Calibrate Mic**. Wait a moment for the following screen to appear:

```
MICROPHONE CALIBRATE
@40kHz :
Ch 0:   ----- dBV
```

To cancel testing and exit the utility, press ◀ **Left**.

5. Turn the calibrator **ON** and set the mode toggle switch to **CAL**. The calibrator generates a 40 kHz tone. You are now ready to test.
6. Testing SMM-U2:
 - a. Remove the clear calibrator microphone adapter by sliding it off the calibrator from the bottom.



- b. Place the microphone flat on the calibrator and then slide the microphone forward until it just touches the toggle switches' threaded shaft as shown.
 - c. Observe the dBV level on the SM4BAT FS display. If the value is higher (less negative) than **-47 dB** your microphone has passed and is ready to use. If the value is lower (more negative) your microphone has lost some or all of its sensitivity and should be replaced.
7. Testing SMM-U1:
 - a. Install the clear calibrator microphone adapter by sliding it onto the calibrator from the bottom (the end with the Wildlife Acoustics logo) until it is touching the toggle switches. Position the side with the smaller diameter hole near the toggle switches.

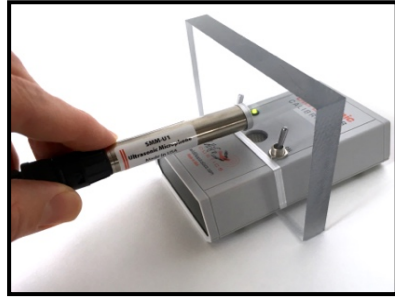
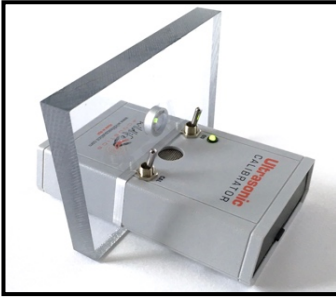

- b. Place the microphone in the calibrator microphone adapter. Insert the microphone until it rests against the smaller opening of the adapter circle.
- c. While looking at the dBv level on the SM4BAT FS display, slowly rotate the microphone 360 degrees. Note the largest (least negative) number. If the value is higher (less negative) than **-38 dB** your microphone has passed and is ready to use. If the value is lower (more negative) your microphone has lost some or all of its sensitivity and should be replaced.

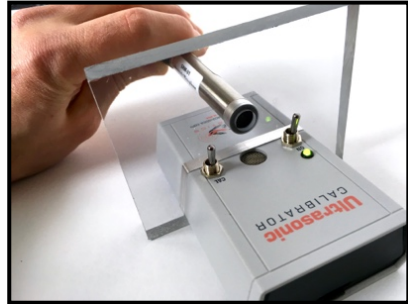

8. Press **◀ Left** when finished to exit the calibration utility.

Chirp Mode System Testing

To test the system, use the Ultrasonic Calibrator to emit loud ultrasonic signals that can be picked up by the recorder from some distance. Analyze the recording files later to verify that the SM4BAT FS settings are appropriate and the system is functioning as expected.

1. Prepare the SM4BAT FS for recording and place it no more than 20 meters away from the calibrator.
2. Remove the microphone adapter from the calibrator as shown.
3. Set the toggle switch to **CHIRP**.
4. The calibrator emits a 100ms long 40kHz (+/- 10Hz) tone every 500ms. The amplitude of the tone is 104dB SPL (+/- 3dB) at 10cm. The signal can be picked up by the SM4BAT FS recorder at distances up to 20 meters.
5. Begin monitoring using **Time Expansion Mode** and monitor with headphones (see *Monitoring Ultrasound in Time Expansion Mode* below) to verify that the signal is being picked up. Or, make a



recording using **Instant Recording** (see *Making an Instant Recording* in Chapter 5) and then analyze the recording files to verify the system is operating as expected.

WARNING! Do not place the Ultrasonic Calibrator near your ears. In **CHIRP** mode, the calibrator emits a 40 kHz signal at over 100 dB SPL. Prolonged exposure to high intensity ultrasonic signals may cause permanent hearing loss at audible frequencies.

9.4 Monitoring Ultrasound in Time Expansion Mode

For real-time ultrasonic monitoring, the recorder can continually capture brief intervals of signals and play them back at a slower rate to bring them into the range of human hearing. The Time Expansion Mode utility divides the frequencies of ultrasonic signals by a selectable factor of 10 or 20, allowing you to monitor them with headphones. This mode scans for ultrasonic signals that satisfy the trigger level and frequency settings in the Audio menu and then captures for the duration you specify in the *Buffer Time* setting. After that time, or when the capture buffer is full, the recorder plays back at reduced speed and then repeats this cycle.

CAUTION: The SM4BAT FS cannot make recordings during Time Expansion monitoring. This mode is designed primarily to allow you to verify functionality of the microphones and recorder.

1. Navigate to **Main Menu > Utilities > Time Expansion Mode:**

```
Time Expansion Mode
-Expansion Factor 10
-Buffer time 1000 ms
-Start monitoring...
```

2. To adjust the **Expansion Factor**, press **ENTER**. Press **▲ Up** to toggle the ratio value from 10 to 20. The default value is 10. Press **ENTER** to save your changes or **◀ Left** to go back.
3. To adjust the **Buffer time**, press **▼ Down** and then press **ENTER** and then press **▲ Up** or **▼ Down** to set a buffer time between 50 milliseconds and 5,000 milliseconds (5 seconds) in 50-millisecond increments. Press **ENTER** to save or **◀ Left** to go back.
4. Verify that you have attached an ultrasonic mic and headphones.



5. When you are ready, select **Start monitoring** and press **ENTER**.
The following screen appears:

```

TIME EXPANSION MODE
Ratio:    10 X
Buffer:  2200 ms
ARMED.....
  
```

CAUTION: Initial headphone volume may be loud.

6. Press **▲ Up** or **▼ Down** to control the volume during playback.

```

TIME EXPANSION MODE
Ratio:    10 X
Buffer:  2200 ms
PLAYBACK.....
  
```

7. Press **SCHEDULE STOP** or **◀ Left** to exit time expansion mode and return to the **Utilities** menu.

9.5 Formatting SD Memory Cards

This procedure formats the inserted SD memory cards. Use this procedure prior to all deployments for optimal performance and to ensure that the cards are empty. The recorder will never overwrite existing data on a card.

This procedure will also clear a card that has been declared DIRTY. A card is labeled DIRTY if a process was interrupted which could have resulted in card corruption, for example a card is pulled from the recorder while it is in the process of recording or the battery voltage goes too low while the recorder is recording. The latter is a likelihood if the recorder is left to record until the batteries die. This is fine, copy recordings to a computer and format the card using this process.

WARNING! This procedure erases all data on the SD memory card. Verify that you have saved any important schedules or recording files before running this utility.

1. Insert an SD memory card in slot A and an optional second card in slot B.

2. Navigate to **Main Menu > Utilities > Format All Cards.**
3. At the **Confirm: Format All?** prompt:
 - Select **No** to cancel this procedure. Any existing data files remain on the SD memory card(s).
 - Select **Yes** to format the SD memory cards in both slots.
4. If you select **Yes**, progress messages appear, and then the display returns to the **Utilities** menu.

9.6 Updating the Firmware

The SM4BAT FS is field-upgradeable. Firmware updates are periodically available with fixes or improvements.

1. Download new firmware from www.wildlifeacoustics.com. (While visiting our website, you can join our mailing list to receive important notices about your SM4BAT FS and related products.)
2. Save or copy the firmware file to the top-level directory (not in a folder) of an SD memory card and insert it into the recorder in slot A.
3. Navigate to **Main Menu > Utilities > Firmware Update.**
The recorder scans the SD memory card for .SM4 firmware files.
4. At the **Select upgrade file** prompt, select the firmware update file and press **ENTER**. The recorder applies the new firmware and restarts.

10 Specifications

10.1 Physical

Length: 8.6 inches (218 mm)
Width: 6.0 inches (152 mm)
Depth: 3.1 inches (78 mm)
Weight: 1.6 pounds (0.73 kg)
Weight with 4 D Batteries: 2.9 pounds (1.3 kg)
Operating Temperature: -4°F to 185°F (-20°C to 85°C) (excluding batteries)
Enclosure: Weatherproof, polycarbonate housing.

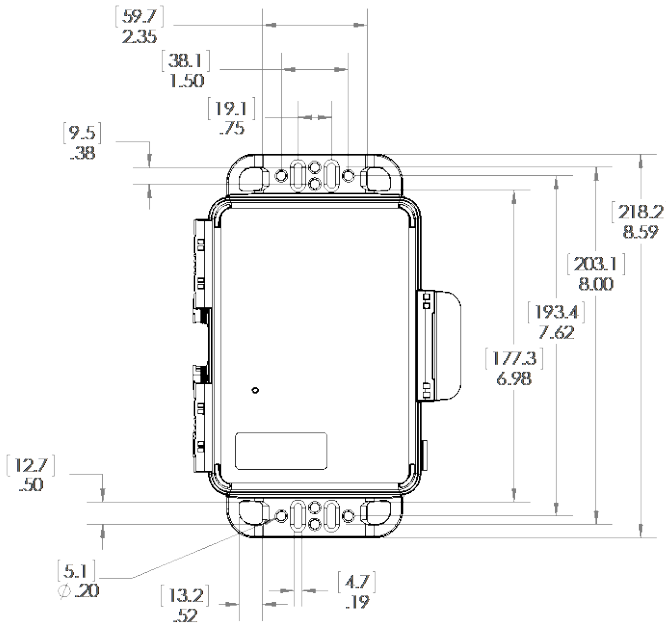
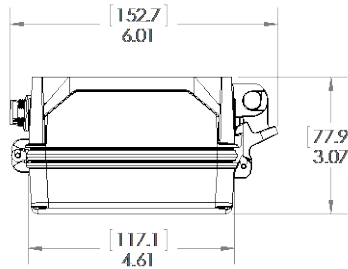

10.2 Power

Battery Specifications: The recorder uses four (4) standard D size disposable alkaline batteries or rechargeable NiMH batteries.

Estimated Recording Time:

Alkaline batteries (14,000 milliamp-hours at 1.5V each):
300 to 480 hours (30 – 48 ten hour nights)

NiMH LSD batteries (9,500 milliamp-hours at 1.2V each):
180 to 280 hours (18 – 28 ten hour nights)

NOTE: Battery life is dependent on bat activity. The above range assumes 100% triggering on the low end and 10% triggering on the high end.

Power Consumption:

State	Sample Rate	mW
Armed	192,000	150
	256,000	138
	384,000	162
	500,000	180
Triggered	192,000	222
	256,000	222
	384,000	228
	500,000	270
10% Triggered	192,000	157
	256,000	146
	384,000	169
	500,000	189
Off		0
Sleeping		0.14

NOTE: Based on their low power consumption in our tests, we recommend SanDisk SDHC/SDXC cards from a reliable vendor (to avoid counterfeits). Recording times will vary with other brands. Other factors, such as battery quality, temperature, and sample rate also affect recording time.

External Power Voltage: 5 – 17 volts DC

Clock Backup Battery Type: 3.0-volt lithium CR2032 (approximate 3-year life)

Internal Clock Accuracy: 3.5ppm from -40°C to 0°C, 2.0ppm from 0°C to 40°C (Temperature-Compensated Crystal)

10.3 SD Memory Cards

Type: Supports SDHC and SDXC (reformatting not required)

Capacity: Supports up to 32 GB SDHC or up to 2 TB SDXC per slot.



10.4 Ultrasonic Audio

Channels: 1

Recording Format: 16-bit PCM WAV

Supported Sample Rates (kHz): 192, 256, 384, and 500

Amplifier Gain: 0 or 12 dB

High Pass Filter: Selectable 2-pole at 16 kHz

Anti-alias Filter: 2-pole at 156 kHz

Equivalent Input Noise: in dBVrms (>10kHz, 0dB gain)

Gain and High Pass Filter	256 and 192 kHz	384 kHz	500 kHz
0dB	-82.4	-81.4	-83.6
0dB+16kHz	-82.4	-81.5	-83.5
12dB	-86.9	-85.2	-85.5
12dB+16kHz	-87.0	-85.5	-85.8

10.5 SMM-U1 Ultrasonic Microphone

Enclosure: Weatherproof stainless steel

Directional Pattern: Omnidirectional

Element: Knowles FG

Output: Differential

Built in high pass filter: 4-pole at 8 kHz

For frequency response and signal to noise graphs and specifications, please go to: <https://www.wildlifeacoustics.com/products/song-meter-sm4bat>

10.6 SMM-U2 Ultrasonic Microphone

Enclosure: Waterproof (IP68) Polycarbonate/ABS

Directional Pattern: Cardioid

Output: Differential

Built in high pass filter: 2-pole at 1 kHz

For frequency response and signal to noise graphs and specifications, please go to: <https://www.wildlifeacoustics.com/products/song-meter-sm4bat>

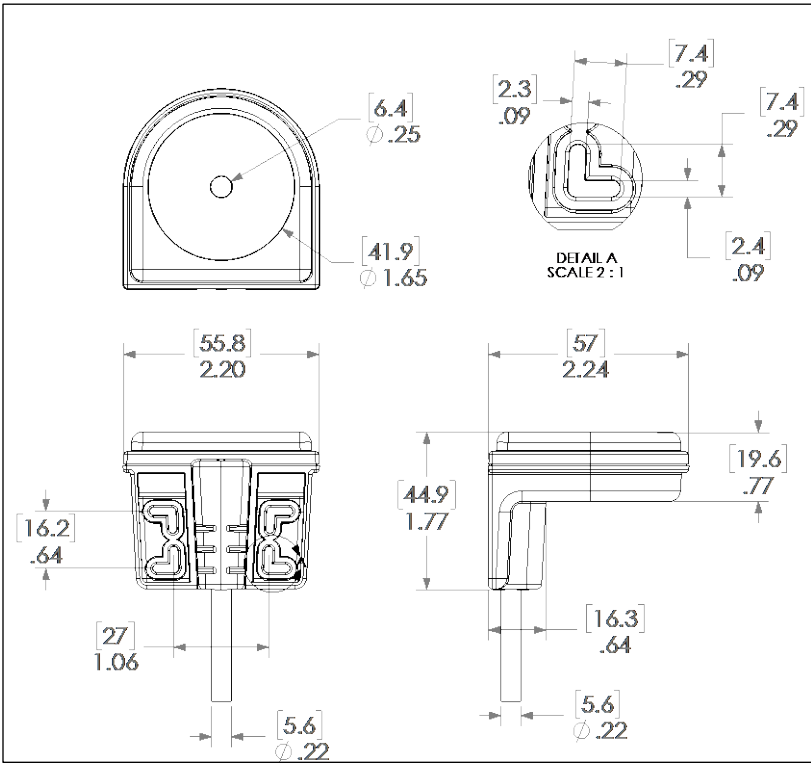

11 Warranty and Disclosures

Except as specifically provided herein, Wildlife Acoustics makes no warranty of any kind, express or implied, with respect to this product.

Hardware Limited Warranty

Product	Components	Warranty Period
Song Meter SM4BAT FS	All components (excluding microphones and accessories)	3 Years
	Microphones (excluding windscreens)	18 Months

Wildlife Acoustics, Inc. Limited Warranty

HARDWARE: Wildlife Acoustics, Inc. ("WAI") warrants to the original end user ("Customer") that new WAI branded products will be free from defects in workmanship and materials, under normal use. Refer to the Hardware Limited Warranty table at the top of this page for the applicable warranty period from the original date of purchase.

WAI warrants refurbished WAI products, marked and sold as such, for ninety (90) days from the original purchase date.

SOFTWARE: WAI warrants to Customer that any WAI branded software will perform in substantial conformance to their schedule specifications for a period of ninety (90) days from the date of original purchase. WAI warrants the media containing software against failure during the warranty period. WAI makes no warranty or representation that the operation of the software products will be uninterrupted or error free, or that all defects in the software products will be corrected.

EXCLUSIONS: This warranty excludes (1) physical damage to the surface of the product, including cracks or scratches on the outside casing; (2) damage caused by misuse, neglect, improper installation or testing, unauthorized attempts to open, repair, or modify the product, or any other cause beyond the range of the intended use; (3) damage caused by accident, fire, power changes, other hazards, or acts of God; or (4) use of the product with any non-WAI device or service if such device or service causes the problem.

Any third party products, including software, included with WAI products are not covered by this WAI warranty and WAI makes no representations or warranties on behalf of such third parties. Any warranty on such products is from the supplier or licensor of the product.

No warranty is provided by WAI unless the product was purchased from an authorized distributor or authorized reseller.

EXCLUSIVE REMEDIES: Should a covered defect occur during the warranty period and you notify WAI, your sole and exclusive remedy shall be, at sole option and expense of WAI, to repair or replace the product or software. If WAI cannot reasonably repair nor replace then WAI may, in its sole discretion, refund the purchase price paid for the product. Replacement products or parts may be new or reconditioned or comparable versions of the defective item. WAI warrants any replaced or repaired product, part, or software for a period of ninety (90) days from shipment, or through the end of the original warranty, whichever is longer.

OBTAINING WARRANTY SERVICE: Customer should refer to the WAI website at www.wildlifeacoustics.com/support/contact-support for information on obtaining warranty service authorization. Methods for obtaining warranty service may vary depending on whether purchases were made from an authorized provider of WAI products or from WAI directly. All requests for warranty service authorization must be made within the applicable warranty period. Dated proof of original purchase will be required. Products or parts shipped by Customer to WAI must be sent postage-paid and packaged appropriately for safe shipment. WAI is not responsible for Customer products received without a warranty service authorization and may be rejected. Repaired or replacement products will be shipped to Customer at WAI expense. All products or parts that are replaced become the property of WAI. WAI shall not be responsible for Customer software, firmware, information, or memory data contained in, stored on, or integrated with any products returned to WAI for repair, whether under warranty or not. The repair and replacement process for products or parts in locations outside of the United States will vary depending on Customer's location.

WARRANTIES EXCLUSIVE: THE FOREGOING WARRANTIES AND REMEDIES ARE EXCLUSIVE AND IN LIEU OF ALL OTHER WARRANTIES, TERMS OR CONDITIONS, EXPRESS, IMPLIED OR STATUTORY, INCLUDING WARRANTIES OF MERCHANTABILITY, FITNESS FOR A PARTICULAR PURPOSE, ACCURACY, CORRESPONDENCE WITH DESCRIPTION, SATISFACTORY QUALITY AND NON-INFRINGEMENT, ALL OF WHICH ARE EXPRESSLY DISCLAIMED BY WAI AND ITS SUPPLIERS.

LIMITATIONS OF LIABILITY: NEITHER WAI NOR ITS SUPPLIERS SHALL BE LIABLE FOR INCIDENTAL, CONSEQUENTIAL, INDIRECT, SPECIAL, OR PUNITIVE DAMAGES OF ANY KIND, LOSS OF INFORMATION OR DATA, LOSS OF REVENUE, LOSS OF BUSINESS OR OTHER FINANCIAL LOSS ARISING OUT OF OR IN CONNECTION WITH THE SALE OR USE OF THIS PRODUCT, WHETHER BASED IN CONTRACT, TORT (INCLUDING NEGLIGENCE), STRICT PRODUCT LIABILITY OR ANY OTHER THEORY, EVEN IF WAI HAS BEEN ADVISED OF THE POSSIBILITY OF SUCH DAMAGES AND EVEN IF ANY LIMITED REMEDY SPECIFIED IN THIS LICENSE AGREEMENT IS DEEMED TO HAVE FAILED OF ITS ESSENTIAL PURPOSE. WAI'S ENTIRE LIABILITY SHALL BE LIMITED TO REPLACEMENT, REPAIR, OR REFUND OF THE PURCHASE PRICE PAID, AT WAI'S OPTION. IN NO EVENT SHALL WAI'S LIABILITY FOR ALL DAMAGES RELATED TO THE PURCHASE OF PRODUCT EXCEED THE AMOUNT PAID FOR THE APPLICABLE PRODUCT. THE FOREGOING LIMITATIONS WILL APPLY EVEN IF THE ABOVE STATED REMEDY FAILS OF ITS ESSENTIAL PURPOSE.

DISCLAIMER: Some countries, states, or provinces do not allow the exclusion or limitation of implied warranties or the limitation of incidental or consequential damages so the above limitations and exclusions may be limited in their application to you. When implied warranties may not be excluded in their entirety, they will be limited to the duration of the applicable written warranty. This warranty gives you specific legal rights; you may have other rights that may vary depending on local law. Your statutory rights are not affected.

GOVERNING LAW: This Limited Warranty shall be governed by the laws of the Commonwealth of Massachusetts, and by the laws of the United States, excluding their conflicts of laws principles. The United Nations Convention on Contracts for the International Sale of Goods is hereby excluded in its entirety from application to this Limited Warranty.

DECLARATION OF CONFORMITY (EN 45014)

Manufacturer:

Wildlife Acoustics, Inc.
3 Mill and Main Place, Suite 210
Maynard, MA 01754
United States of America



Declares that the following product:

Product Name: Song Meter
Product Model Number: SM4BAT FS
Product Type: Bioacoustics Recorder

Conforms to the appropriate country standards and governing regulations listed below and/or on the following page. As the manufacturer, we are fully responsible for the design and production of the above-mentioned equipment.

- Federal Communications Commission Rules Part 15, Class A
- AS/NZS CISPR 11, 2011, Industrial, scientific and medical (ISM) radio-frequency equipment – electromagnetic disturbance characteristics – limits and methods of measurement, Class A
- EN 55011, 2009/A1, 2010, Industrial, scientific and medical (ISM) radio-frequency equipment – Electromagnetic disturbance characteristics – Limits and methods of measurement, Class A
- ICES-003, 2012, Industry Canada, Interference-Causing Equipment Standard, Digital Apparatus, Class A
- EN61326, 2013 Electrical Equipment for Measurement, Control and Laboratory use EMC Requirements
- EN61000-4-2 Electrostatic Discharge
- EN61000-4-3 Radiated Electromagnetic Fields
- Tested at operating temperatures of -20C to +55C. Testing included 24-hour soaks at both extremes plus 6 cycles for one hour each.
- Tested at operating humidity of 95% relative humidity at +40C. Testing included 24-hour soak.
- Tested for vibration as per the MIL-STD-810G Method 514.6, category 4 standard.
- IEC 60529 IPX5 (Water Jet Test)
- IEC 60529 IPX6 (Powerful Water Jet Test)
- IEC 60529 IPX7 (Temporary Immersion)

This product was tested in a typical configuration.

Ian Agranat, President
Wildlife Acoustics, Inc.
January 19, 2016

ELECTROMAGNETIC INTERFERENCE

This equipment has been tested and found to comply with the limits for a Class A digital device, pursuant to Part 15 of the FCC Rules.

These limits are designed to provide reasonable protection against harmful interference when the equipment is operated in a commercial environment. This equipment generates, uses, and can radiate radio frequency energy and, if not installed and used in accordance with the instruction manual, may cause harmful interference to radio communications. Operation of this equipment in a residential area is likely to cause harmful interference in which case the user will be required to correct the interference at his own expense.

Changes or modifications not expressly approved by Wildlife Acoustics, Inc. could void the user's authority to operate the equipment.

Note: Use of ferrite clamped cables are required to comply with the Class A limits in part 15 of the FCC rules. A Fair-Rite 0431164181 ferrite clamp (or equivalent) must be placed on each cable near the recorder with the ferrite residing within one loop of the cable. This clamp is provided with all cables sold by Wildlife Acoustics.

PRODUCT DOCUMENTATION

©2015-2020 Wildlife Acoustics, Inc. All Rights Reserved.

This documentation may not be reproduced or distributed in any form or by any means, graphic, electronic, or mechanical, including but not limited to photocopying, scanning, recording, taping, e-mailing, or storing in information storage and retrieval systems without the written permission of Wildlife Acoustics. Products that are referenced in this document such as Microsoft Windows® may be trademarks and/or registered trademarks of their respective owners. Wildlife Acoustics makes no claim to these trademarks. While every precaution has been taken in the preparation of this document, individually, as a series, in whole, or in part, Wildlife Acoustics, the publisher, and the author assume no responsibility for errors or omissions, including any damages resulting from the express or implied application of information contained in this document or from the use of products, services, or programs that may accompany it. In no event shall Wildlife Acoustics, publishers, authors, or editors of this guide be liable for any loss of profit or any other commercial damage caused or alleged to have been caused directly or indirectly by this document

Song Meter SM4BAT FS

BIOACOUSTICS RECORDER

User Guide

©2016-2022 Wildlife Acoustics, Inc. All Rights Reserved.

Wildlife Acoustics, Kaleidoscope and Song Meter are registered with the U.S. Patent and Trademark Office.

SM4BAT FS is a trademark of Wildlife Acoustics, Inc.

SDHC and SDXC Logos are trademarks of SD-3C,LLC.

All other trademarks are the property of their respective owners.

The Song Meter SM4BAT FS is covered under the following patents:

US 7,782,195

EP 3347898

EP 2742328

US D801,683

US 9,762,987

US 8,627,723

Wildlife Acoustics, Inc.

3 Mill and Main Place, Suite 210

Maynard, MA 01754

(978) 369-5225 or toll-free in the U.S. (888) 733-0200

www.wildlifeacoustics.com



WILDLIFE

ACOUSTICS